

# **FORCE DPT**

***Push The Limit!***

---

## **DIRECT PUSH TOOLING CATALOG**

---

**TOOLING SYSTEMS**

**SOIL SAMPLING SYSTEMS**

**GROUNDWATER SAMPLING SYSTEMS**

**www.hole PRODUCTS.com**





# hole PRODUCTS

*Drill with us.*

## OUR LOCATIONS

### California

1413 E. Philadelphia St.  
Ontario, CA 91761  
Toll free (844) 573-0854  
Phone (909) 939-2581  
Fax (909) 891-0434

### Florida

6448 Pinecastle Blvd., Suite 105  
Orlando, FL 32809  
Toll free (877) 544-4211  
Phone (407) 792-2670  
Fax (407) 286-2956

### Georgia

1725 Corporate Dr., Suite 340  
Norcross, GA 30093  
Toll free (888) 448-4430  
Phone (770) 279-8755  
Fax (770) 279-8499

### Minnesota

205 16th St. NE., Suite A  
Little Falls, MN 56345  
Phone (320) 616-0701  
Fax (320) 631-0064

### Missouri

4061 Wedgeway Ct.  
Earth City, MO 63045  
Toll free (877) 699-2159  
Phone (314) 282-2740  
Fax (314) 770-0687

### New Jersey

9 Astro Place, Unit #3  
Rockaway, NJ 07866  
Toll free (888) 379-0371  
Phone (862) 254-8000  
Fax (862) 210-6000

### Wisconsin

7575 Bombardier Ct., Suite 300  
Wausau, WI 54401  
Toll free (888) 465-3704  
Phone (715) 842-0000  
Fax (715) 842-5999

### Global Sales

(888) 465-1569

## INDUSTRIES & MARKETS

### DIRECT PUSH - PROBE

---

A full line of Geoprobe® compatible direct push tooling and accessories innovatively designed and manufactured to provide consistency, durability, and longevity. Large inventory, multiple stocking locations, local delivery, and global logistical solutions.

### ENVIRONMENTAL & GEOTECHNICAL

---

Auger tools, rods and subs, bits, sampling equipment, well completion products, and more. One call for all of your environmental and geotechnical product needs.

### GEOTHERMAL

---

Our IGSHA certified staff can provide quality products and solutions for both geothermal installations and geothermal drilling.

### HDD

---

A full line of Ditch Witch® and Vermeer® compatible HDD drilling tools and accessories, backed by second to none service and support.

### MINERAL EXPLORATION

---

Quality, innovative tooling, and accessories to support all methods of exploratory drilling. Large on-hand inventory and worldwide shipping capabilities.

### ROTARY

---

A vast inventory of tooling and accessories to service air, mud, and reverse circulation rotary drilling operations.

### SONIC

---

World class tooling, designed and manufactured specifically to withstand the rigors unique to sonic drilling. On-site solutions you just can't find anywhere else.

### Use of Trademarks, Company Affiliations and Other Legal Disclaimers.

Unless otherwise stated in the catalog, Hole Products, LLC is in no way affiliated with, or endorsed by, the independent companies listed throughout this catalog including but not limited to, GeoProbe Systems®, DITCH WITCH®, and VERMEER®.

Catalog references to company names and/or products are for identification purposes only, and should not be considered any form of affiliation with, or endorsement of, Hole Products, LLC.

GEOPROBE® and GEOPROBE SYSTEMS® are registered trademarks of Kejr Engineering, Inc., Salina, KS.

There is no affiliation between Kejr Engineering, Inc. and Hole Products, LLC.

DITCH WITCH® is a registered trademarks of Charles Machine Works, Perry, OK. There is no affiliation between Charles Machine Works and Hole Products, LLC.

VERMEER® is a registered trademarks of Vermeer Manufacturing Company, Pella, IA. There is no affiliation between Vermeer Manufacturing Company and Hole Products, LLC.

# DIRECT PUSH TOOLING

## TABLE OF CONTENTS

<b>TOOLING SYSTEMS &amp; ACCESSORIES .....</b>	<b>1-15</b>
• 1.25" .....	2-3
• 1.50" .....	4-5
• 2.25" .....	6-7
• 3.25" .....	8-9
• 3.50" .....	10-11
• 3.75" .....	12-13
• 4.50" .....	14-15
<b>SOIL SAMPLING SYSTEMS .....</b>	<b>17-33</b>
• MC5 .....	18-20
• MC7 .....	22-23
• DT22 .....	24-25
• DT325 .....	26-27
• DT35 .....	28-29
• DT37 .....	30-31
• DT45 .....	32-33
<b>GROUNDWATER SAMPLING &amp; ASSESSMENT SYSTEMS .....</b>	<b>35-41</b>
• SP16 .....	36-37
• SP22 .....	38-39
• Prepacked Screen.....	40-41
<b>ADDITIONAL TOOLING &amp; ACCESSORIES .....</b>	<b>43-50</b>
• Expendable Point Holders.....	44
• Expendable Points .....	45
• Solid Points .....	46
• Pull Caps .....	47
• Probe Rods .....	48
• Lightweight Probe Rods .....	49
• Extension Rods & Accessories.....	49
• Rod Wipers .....	49
• Nylon Brushes .....	50
• Subs & Adapters.....	50
• Retainer Wrenches .....	50
<b>PART NUMBER REFERENCE GUIDE .....</b>	<b>51-58</b>



# **Force DPT**

**Direct push tooling.**

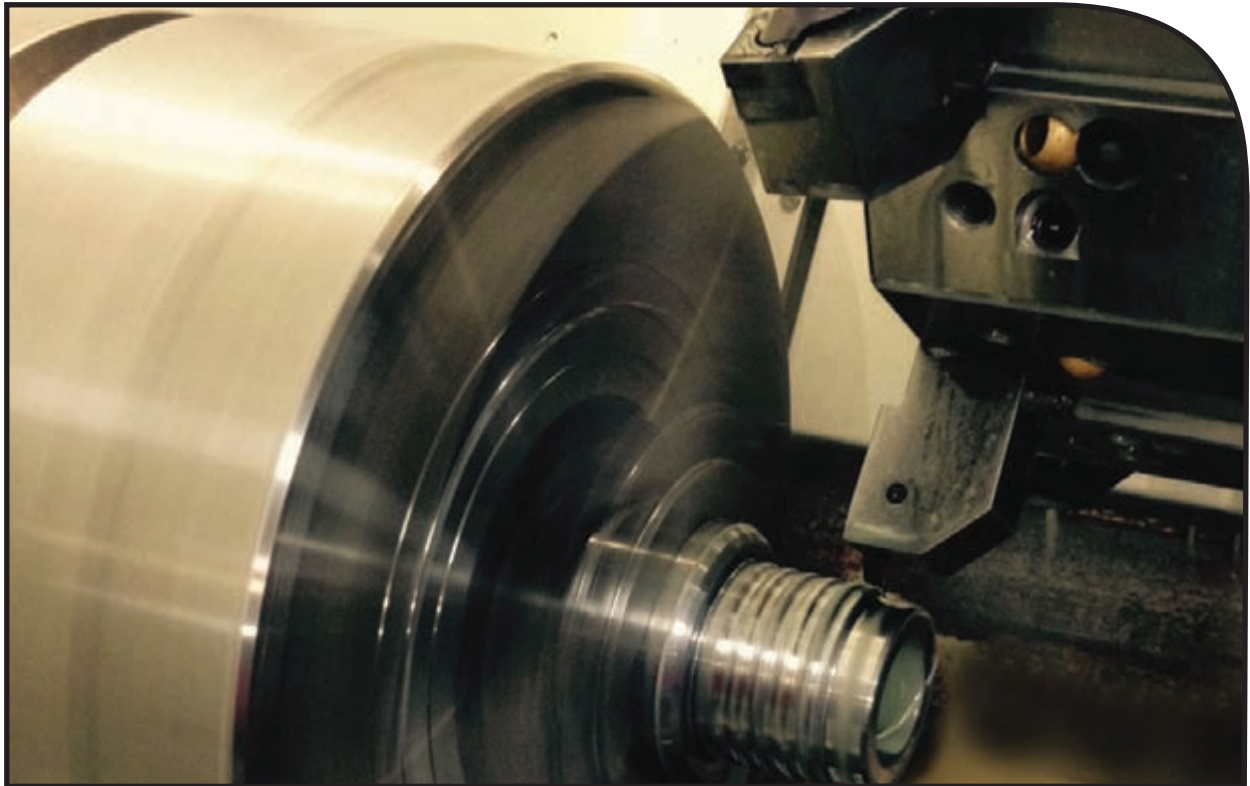

Direct Push Technology (DPT) utilizes direct push (probe) rigs to push tools and sensors into the ground to advance sampling devices and geotechnical or analytical sensors into the subsurface.

Direct Push is often the preferred drilling method for geotechnical and environmental projects. Cost effectiveness, versatility, and efficiency are some of the many advantages of direct push. In addition, probes produce minimal cuttings and waste, thus saving time and reducing overall job-site costs associated with handling, removal, and clean-up of waste often associated with other traditional drilling methods.

To service the Direct Push market, Hole Products brings you **Force DPT**. The **Force** line of world class, industry compatible tooling includes: tooling systems ranging from 1.25" – 4.50", soil sampling systems, groundwater sampling and assessment systems, field accessories, and much more.

With an unrivalled inventory, in-stock at multiple locations throughout the US, coupled with Hole Products sales, service, and distribution network, Force DPT provides drillers the direct push alternative they've been waiting for.

Please contact a **Force** representative for additional details, product availability, or assistance ordering **The Genuine Alternative!**

*Products listed in the catalog are representative of the most common industry sizes and styles.  
Please contact your Hole Products representative for additional product offerings.*

# 1.25" PROBE TOOLS

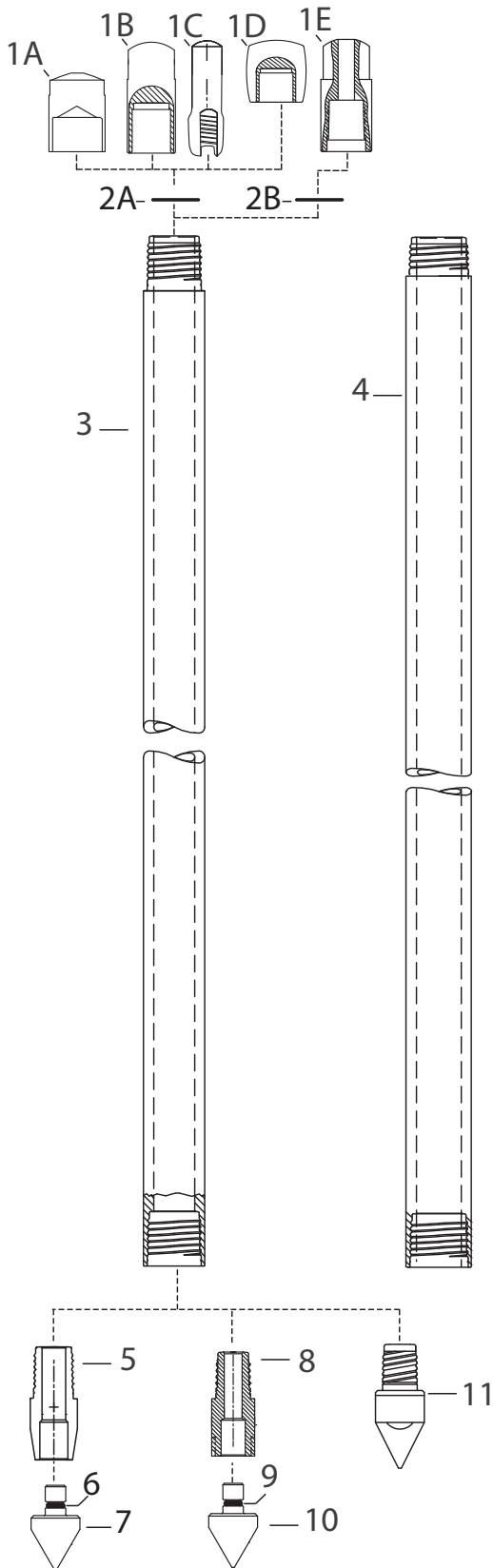

ACCESSORIES		
12A 	12B 	12C 
12D 	12E 	12F 
12G 	13 	14 
15 	16 	17 

# 1.25" PROBE TOOLS

1.25" PROBE TOOLS				
ITEM	HP PART #	GP PART #	GP MAT #	DESCRIPTION
1A	4020181	N/A	N/A	1.25" DRIVE CAP, SHORT, THREADLESS (GH40 HAMMER)
	4030007	AT1200	213748	1.25" DRIVE CAP, SHORT, W/ THREADS (G40 HAMMER)
1B	4020206	35392	207282	1.25" DRIVE CAP, LONG, THREADLESS (GH40 HAMMER)
1C	4020205	AT1202	213749	1.25" DRIVE CAP, SLOTTED, 5.50" LONG (GH40 HAMMER)
1D	4020204	8398	201089	1.25" DRIVE CAP, THREADLESS (GH60 HAMMER)
1E	4020209	AT1266	213775	1.25" DRIVE CAP, GAS SAMPLING
2A	4020217	AT1250R	213771	O-RING, 1.25" PROBE ROD (25/PKG)
2B	4020218	AT1266R	213776	O-RING, 1.25" GAS SAMPLING CAP (25/PKG)
3	4030279	AT1212	213753	1.25" X 12" PROBE ROD
	4030222	AT1224	213758	1.25" X 24" PROBE ROD
	4020229	AT1236	213762	1.25" X 36" PROBE ROD
	4020230	AT1239	213763	1.25" X 39"/1M PROBE ROD
	4030270	AT1248	213769	1.25" X 48" PROBE ROD
	4030267	AT1260	213773	1.25" X 60" PROBE ROD
4	4020227	43012	209949	1.25" X 36" LIGHTWEIGHT PROBE ROD
	4020226	32318	206525	1.25" X 39"/1M LIGHTWEIGHT PROBE ROD
	4030224	21900	203988	1.25" X 48" LIGHTWEIGHT PROBE ROD
	4030277	27600	205232	1.25" X 60" LIGHTWEIGHT PROBE ROD
5	4020212	PR1215	214202	1.25" EXPENDABLE POINT HOLDER FOR 1.10" OD EXPENDABLE POINT
6	4030225	AT14R	213782	O-RING, 1.00" FOR 1.10" OD EXPENDABLE POINT (25/PKG)
7	4020835	AT14	213778	1.00" EXPENDABLE POINT (1.10" OD)
	4030115	PR14	214205	1.00" EXPENDABLE POINT W/ 1.10" OD FOR SOIL GAS IMPLANTS W/ O-RING
8	4030466	AT1213	213754	1.25" EXPENDABLE POINT HOLDER FOR 1.45" OD EXPENDABLE POINT
9	4030425	AT1214R	N/A	O-RING, 1.25" FOR 1.45" OD EXPENDABLE POINT (25/PKG)
10	4020208	AT1214	N/A	1.25" EXPENDABLE POINT W/ O-RING (1.45" OD)
	4020219	PR1214	214201	1.25" EXPENDABLE POINT W/ O-RING (1.45" OD) SOIL GAS IMPLANT
11	4020221	AT1245	213767	1.25" SOLID DRIVE POINT (1.45" OD)
	4020241	AT1244	213766	1.25" SOLID DRIVE POINT (1.75" OD)
	4020242	AT1247	213768	1.25" SOLID DRIVE POINT (2.00" OD)
	4020243	AT1242	213765	1.25" SOLID DRIVE POINT (2.50" OD)
	4020244	AT1252	213772	1.25" SOLID DRIVE POINT (3.00" OD)
12A	4030468	N/A	N/A	1.25" DRIVE/PULL CAP, LONG
12B	4030059	AT1204	213751	1.25" PULL CAP
12C	4030427	43343	210092	1.25" LIFTING SWIVEL PULL CAP
12D	4020232	16697	202929	1.25" GROUT INJECTION PULL CAP
12E	4030455	18017	203208	O-RING, 1.25" GROUT INJECTION PULL CAP
12F	4020833	17267	203036	1.25" PULL CAP W/ 1/2" NPT FEMALE THREAD
12G	4020231	AT1203	213750	1.25" PULL CAP, SLOTTED
13	4020234	31499	206239	1.25" LEAF PULLER ASSEMBLY
14	4020210	GH1255	213950	1.25" ROD GRIP HANDLE ASSEMBLY (GH40 HAMMER)
	4020220	15554	202724	1.25"/1.50" ROD GRIP HANDLE ASSEMBLY (GH60 HAMMER)
15	4020202	23663	204400	1.25"/1.50" ROD GRIP BODY (GH40 HAMMER)
	4020203	23418	204305	1.25"/1.50" ROD GRIP BODY (GH60 HAMMER)
16	4020214	5867	200685	1.00"/1.25" ROD GRIP JAW (GH40 HAMMER)
	4020216	15275	202660	1.25"/1.50" ROD GRIP JAW (GH60 HAMMER)
17	4020211	23852	600341	1.25"/1.50" ROD WIPER
*	4030477	BU1250	600996	1.25" NYLON ROD BRUSH
*	4020200	15812	202789	ADAPTER, 1.25" BOX TO 1.50" PIN
*	4020201	15813	202790	ADAPTER, 1.50" BOX TO 1.25" PIN

\* Image not shown. See page 50 for additional details.

# 1.50" PROBE TOOLS

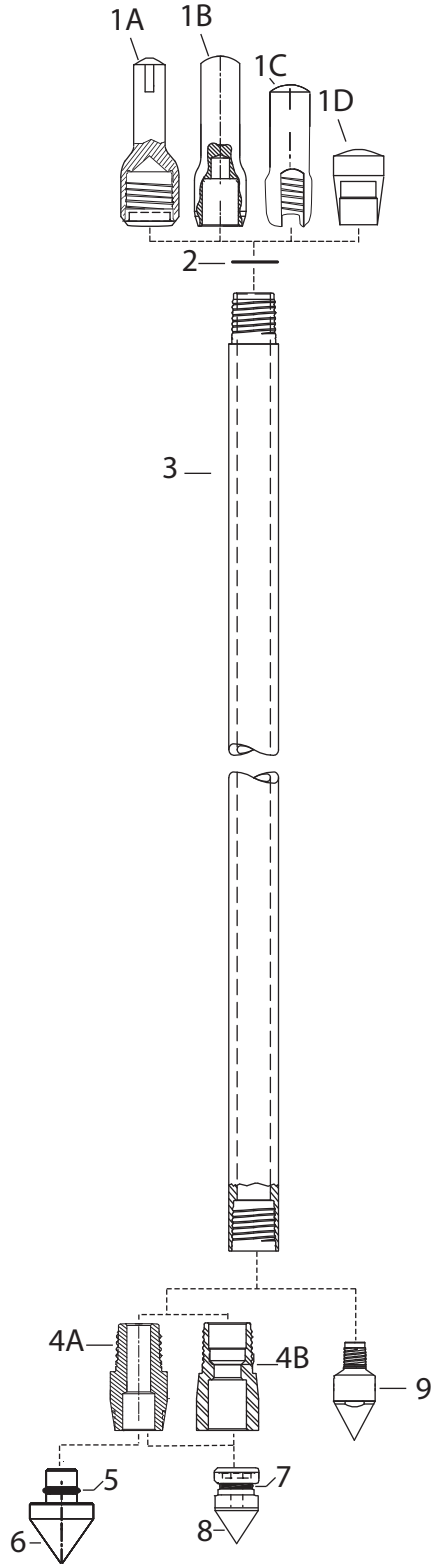

ACCESSORIES		
10A	10B	
10C	10D	10E
11	12	
13	14	15



# 1.50" PROBE TOOLS

1.50" PROBE TOOLS				
ITEM	HP PART #	GP PART #	GP MAT #	DESCRIPTION
1A	4020403	15590	202736	1.50" DRIVE CAP, W/ THREADS (GH40 HAMMER)
1B	4020400	N/A	N/A	1.50" DRIVE CAP, THREADLESS (GH40 HAMMER)
1C	4020402	15607	202743	1.50" DRIVE CAP, SLOTTED, W/ THREADS (GH40 HAMMER)
1D	4030041	12787	202115	1.50" DRIVE CAP, THREADLESS (GH60 HAMMER)
1E*	4020401	21075	N/A	1.50" DRIVE CAP, SLOTTED, THREADLESS (GH40 HAMMER)
2	4030429	15389	202695	O-RING FOR 1.50" PROBE ROD (25/PKG)
3	4030232	15471	202714	1.50" X 12" PROBE ROD
	4020412	15472	202715	1.50" X 24" PROBE ROD
	4020413	35325	207261	1.50" X 36" PROBE ROD
	4020411	17899	203193	1.50" X 39"/1M PROBE ROD
	4020414	13359	202248	1.50" X 48" PROBE ROD
	4030235	11121	201682	1.50" X 60" PROBE ROD
4A	4020407	21444	203895	1.50" EXPENDABLE POINT HOLDER FOR 1.10" OD POINT
4B	4020406	15132	202615	1.50" EXPENDABLE POINT HOLDER FOR 1.70" OD POINT
5	4020228	N/A	N/A	O-RING, 1.50" FOR 1.70" OD EXPENDABLE POINT (25/PKG)
6	4020409	N/A	N/A	1.50" EXPENDABLE POINT W/ O-RING (1.70" OD)
7	4030225	AT14R	213782	O-RING, 1.00" FOR 1.10" OD EXPENDABLE POINT (25/PKG)
8	4020835	AT14	213778	1.00" EXPENDABLE POINT (1.10" OD)
	4030115	PR14	214205	1.00" EXPENDABLE POINT W/ 1.10" OD FOR SOIL GAS IMPLANTS W/ O-RING
9	4020420	21519	203909	1.50" SOLID DRIVE POINT THREADED (1.50" OD)
	4020421	15219	202637	1.50" SOLID DRIVE POINT THREADED (1.70" OD)
	4020422	14512	202494	1.50" SOLID DRIVE POINT THREADED (2.50" OD)
	4020423	12814	202121	1.50" SOLID DRIVE POINT THREADED (3.00" OD)
10A	4030058	15090	202598	1.50" PULL CAP STANDARD NECK
10B	4020415	15164	202630	1.50" PULL CAP W/ SLOT
10C	4030345	42416	209748	1.50" LIFTING SWIVEL PULL CAP
10D	4030455	18017	203208	1.50" GROUT INJECTION PULL CAP
10E	4020452	37303	105017	O-RING, 1.50" GROUT INJECTION PULL CAP
11	4020417	40167	208806	1.50" LEAF PULLER ASSEMBLY
12	4020425	GH1555	213951	1.50" ROD GRIP HANDLE ASSEMBLY (GH40 HAMMER)
	4020220	15554	202724	1.25"/1.50" ROD GRIP HANDLE ASSEMBLY (GH60 HAMMER)
13	4020202	23663	204400	1.25"/1.50" ROD GRIP BODY (GH40 HAMMER)
	4020203	23418	204305	1.25"/1.50" ROD GRIP BODY (GH60 HAMMER)
14	4030069	15582	202730	1.50" ROD GRIP JAW (GH40 HAMMER)
	4020216	15275	202660	1.25"/1.50" ROD GRIP JAW (GH60 HAMMER)
15	4020211	23852	600341	1.25"/1.50" ROD WIPER
**	4020200	15812	202789	ADAPTER, 1.25" BOX TO 1.50" PIN
**	4020201	15813	202790	ADAPTER, 1.50" BOX TO 1.25" PIN

\* Image not shown.

\*\*Image not shown. See page 50 for additional details.

# 2.25" PROBE TOOLS

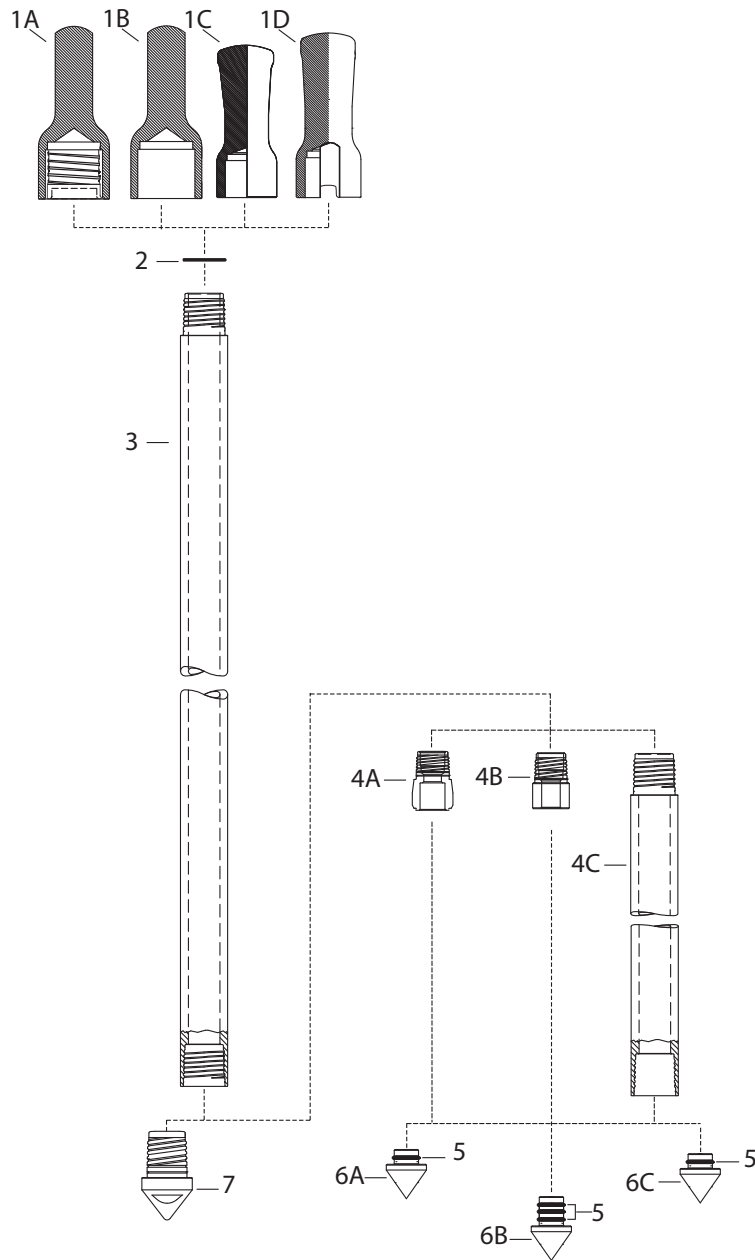

ACCESSORIES		
8A	8B	
8C	8D	
8E	8F	9
10	11	
12	13	14

## 2.25" PROBE TOOLS

2.25" PROBE TOOLS				
ITEM	HP PART #	GP PART #	GP MAT #	DESCRIPTION
1A	4020304	25362	204787	2.25" DRIVE CAP, W/ THREADS (GH40 HAMMER)
1B	4020303	31405	206187	2.25" DRIVE CAP, THREADLESS (GH40 HAMMER)
1C	4030046	31530	206249	2.25" DRIVE CAP, THREADLESS, LONG (GH60 HAMMER)
1D	4030026	48181	211798	2.25" DRIVE CAP, SLOTTED, THREADLESS (GH60 HAMMER)
2	4020312	AT2100R	213790	O-RING, 2.25" PROBE ROD (25/PKG)
3	4020323	25351	204777	2.25" X 12" PROBE ROD
	4030242	32656	206588	2.25" X 24" PROBE ROD
	4020324	33245	206706	2.25" X 36" PROBE ROD
	4020325	25352	204778	2.25" X 39"/1M PROBE ROD
	4030244	25300	204766	2.25" X 48" PROBE ROD
	4030245	25301	204767	2.25" X 60" PROBE ROD
4A	4020139	25353	204779	2.25" EXPENDABLE POINT HOLDER SHORT (2.50" OD)
4B	4020311	28662	205481	2.25" EXPENDABLE POINT HOLDER SHORT (2.25" OD)
4C	4020309	25355	204781	2.25" EXPENDABLE POINT HOLDER 48" LONG (2.25" OD)
	4020310	25356	204782	2.25" EXPENDABLE POINT HOLDER 60" LONG (2.25" OD)
5	4020426	2799	200282	O-RING, 2.25" EXPENDABLE POINT (32/PKG)
6A	4020034	AT2015	213788	2.25" EXPENDABLE POINT STANDARD (2.45" OD) W/ 1 O-RING
6B	4020314	19442	203530	2.25" EXPENDABLE POINT EXT. SHANK (2.45" OD) W/ 3 O-RINGS
6C	4020315	13896	202356	2.25" EXPENDABLE POINT IMPLANT ANCHOR (2.45" OD)
7	4020319	25295	204764	2.25" SOLID DRIVE POINT (2.50" OD)
	4020320	25357	204783	2.25" SOLID DRIVE POINT (3.00" OD)
	4020321	25358	204784	2.25" SOLID DRIVE POINT (3.50" OD)
8A	4020326	33622	206823	2.25" PULL CAP HD
8B	4020327	33882	206876	2.25" LIFTING SWIVEL PULL CAP, BOX DOWN
8C	4020328	35621	207352	2.25" LIFTING SWIVEL PULL CAP, PIN DOWN
8D	4030025	35311	207256	2.25" FLANGE PULL ROD
8E	4030421	37275	207845	2.25" GROUT INJECTION PULL CAP
8F	4020452	37303	105017	O-RING, 2.25" GROUT INJECTION PULL CAP
9	4020329	32952	206643	2.25" LEAF PULLER ASSEMBLY
10	4020335	29461	205678	2.25" ROD GRIP HANDLE ASSEMBLY (GH40 HAMMER)
	4020332	29385	205664	2.25" ROD GRIP HANDLE ASSEMBLY (GH60 HAMMER)
11	4020336	23664	204401	2.25" ROD GRIP BODY (GH40 HAMMER)
	4020333	23666	204403	2.25" ROD GRIP BODY (GH60 HAMMER)
12	4020337	29457	205676	2.25" ROD GRIP JAW (GH40 HAMMER)
	4020334	28930	205565	2.25" ROD GRIP JAW (GH60 HAMMER)
13	4020330	14506	202491	2.25" CENTERING TOOL FOR EXTENSION RODS
14	4020331	26876	600412	2.25" ROD WIPER
*	4020302	BU2125	600998	2.25" NYLON BRUSH
*	4020300	25359	204785	ADAPTER, 2.25" BOX TO 1.50" PIN
*	4020301	25360	204786	ROD TO CAP ADAPTER, 2.25" PIN TO HSA

\* Image not shown. See page 50 for additional details.

# 3.25" PROBE TOOLS

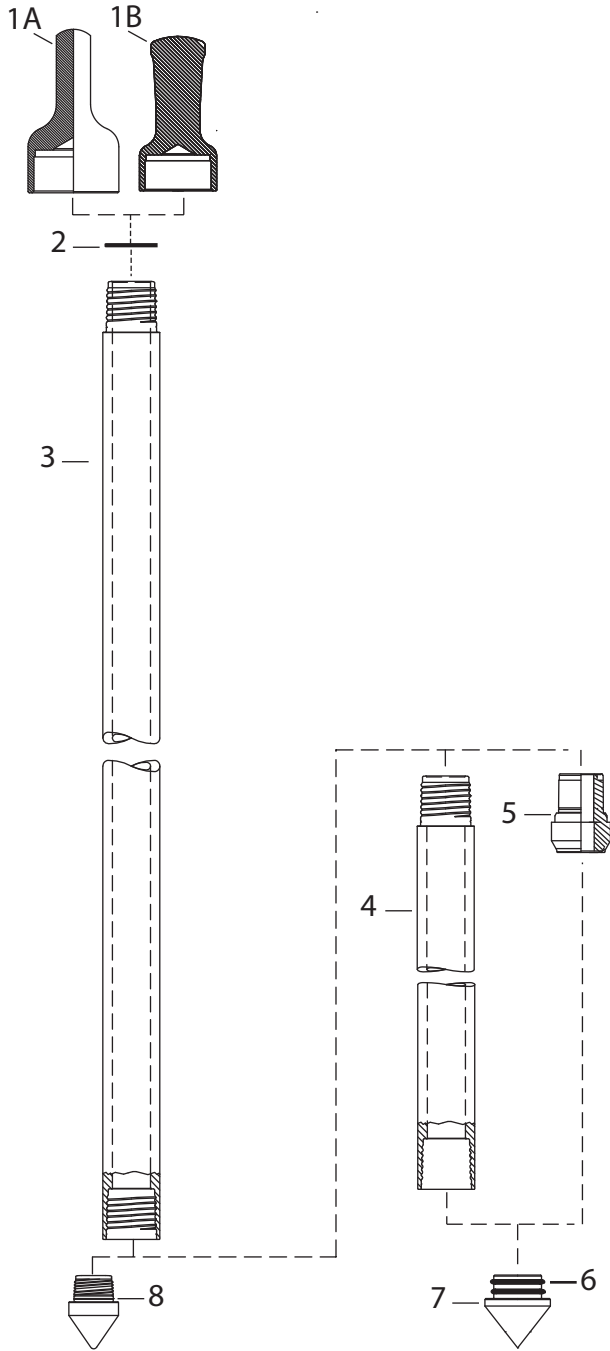

ACCESSORIES		
9A	9B	
9C	10	11
12	13	14
15	16	17
18	19	
20	21	

## 3.25" PROBE TOOLS

3.25" PROBE TOOLS				
ITEM	HP PART #	GP PART #	GP MAT #	DESCRIPTION
1A	4020500	10605	201448	3.25" DRIVE CAP, THREADLESS (GH40 HAMMER)
1B	4030049	9742	201275	3.25" DRIVE CAP, THREADLESS (GH60 HAMMER)
2	4020514	9960	201325	O-RING, 3.25" PROBE ROD (25/PKG)
3	4020508	13672	202313	3.25" X 12" PROBE ROD
	4030252	18405	203284	3.25" X 24" PROBE ROD
	4020509	N/A	N/A	3.25" X 36" PROBE ROD
	4020510	13925	202363	3.25" X 39"/1M PROBE ROD
	4020511	10594	201446	3.25" X 48" PROBE ROD
	4030250	9040	201185	3.25" X 60" PROBE ROD
4	4020501	13926	202364	3.25" EXPENDABLE POINT HOLDER 39"/1M LONG
	4020504	10596	201447	3.25" EXPENDABLE POINT HOLDER 48" LONG
	4030055	9796	201282	3.25" EXPENDABLE POINT HOLDER 60" LONG
5	4030096	N/A	N/A	3.25" EXPENDABLE POINT HOLDER SHORT (3.25" OD)
	4020140	12270	202026	3.25" EXPENDABLE POINT HOLDER SHORT (4.00" OD)
6	4020513	AT3215R	213800	O-RING, 3.25" EXPENDABLE POINT (26/PKG)
	4020519	16490	600207	O-RING, 3.25" EXPENDABLE POINT (EACH)
7	4020505	N/A	N/A	3.25" EXPENDABLE POINT W/ O-RING - ALUMINIUM
	4020507	N/A	N/A	3.25" EXPENDABLE POINT W/ O-RING - LONG
	4020038	AT3215	213798	3.25" EXPENDABLE POINT W/ O-RING - STEEL
8	4020520	9729	201273	3.25" SOLID DRIVE POINT (3.50" OD)
9A	4030050	13257	202234	3.25" PULL CAP
9B	4020517	35358	207272	3.25" LIFTING SWIVEL PULL CAP, BOX DOWN
9C	4030431	35369	207277	3.25" FLANGE PULL ROD
10	4020523	12235	202012	3.25" ROD GRIP HANDLE ASSEMBLY (GH40 HAMMER)
11	4020524	23665	204402	3.25" ROD GRIP BODY (GH40 HAMMER)
12	4020525	12228	202008	3.25" ROD GRIP JAW (GH40 HAMMER)
13	4020526	9757	201277	3.25" ROD GRIP HANDLE ASSEMBLY (GH60 HAMMER)
14	4020527	9096	201189	3.25" ROD GRIP BODY (GH60 HAMMER)
15	4020308	16792	202948	3.25"/3.50" ROD GRIP HAMMER V-BLOCK (GH60 HAMMER)
16	4020316	6370	101149	3.25" ROD GRIP SCREW
17	4030470	12126	201963	3.25" ROD GRIP JAW PAD (GH60 HAMMER)
18	4020470	9774	201280	3.25" ROD GRIP V-BLOCK RETAINING PIN
19	4020521	21114	203844	3.25" SPT SOLID DRIVE POINT W/ 1.50" MALE THREAD FOR SPLIT SPOON
20	4020522	20737	203799	3.25" SPT CUTTING SHOE W/ 2.38" ID x 3.750" OD FOR SPLIT SPOON
21	4020518	27194	600418	3.25" ROD WIPER
*	4020516	BU3250	601000	3.25" NYLON BRUSH

\* Image not shown. See page 50 for additional details.

# 3.50" PROBE TOOLS

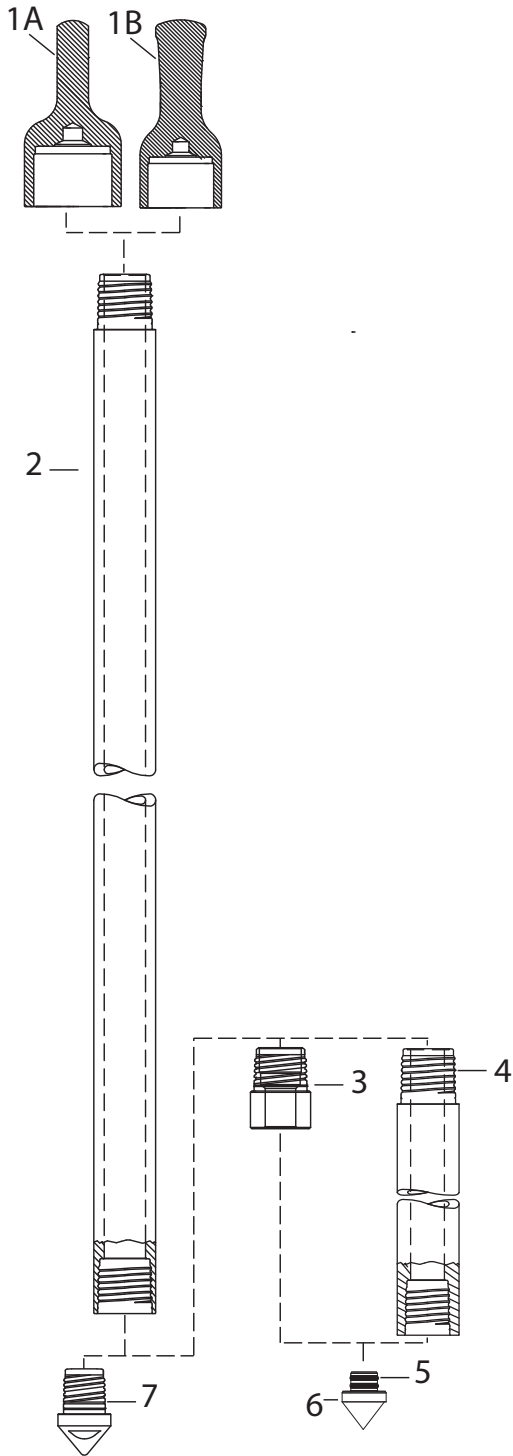

ACCESSORIES			
8A 	8B 	8C 	9 
10 	11 	12 	13 
14 	15 	16 	

## 3.50" PROBE TOOLS

3.50" PROBE TOOLS				
ITEM	HP PART #	GP PART #	GP MAT PART #	DESCRIPTION
1A	4030605	38982	208460	3.50" DRIVE CAP, THREADLESS (GH40 HAMMER)
1B	4030057	36642	207679	3.50" DRIVE CAP, THREADLESS (GH60/80 HAMMER)
2	4020601	51765	213362	3.50" X 12" PROBE ROD
	4030266	38173	208219	3.50" X 24" PROBE ROD
	4020602	N/A	N/A	3.50" X 36" PROBE ROD
	4020603	38952	214781	3.50" X 39"/1M PROBE ROD
	4030264	38951	208446	3.50" X 48" PROBE ROD
	4030265	36641	215664	3.50" X 60" PROBE ROD
3	4020606	N/A	N/A	3.50" EXPENDABLE POINT HOLDER SHORT (3.75" OD)
4	4030084	38955	208449	3.50" EXPENDABLE POINT HOLDER 39"/1M LONG
	4030075	38953	208447	3.50" EXPENDABLE POINT HOLDER 48" LONG
	4020240	37763	208069	3.50" EXPENDABLE POINT HOLDER 60" LONG
5	4030433	N/A	105218	O-RING, 3.50" EXPENDABLE POINT (26/PKG)
6	4020600	39182	208504	3.50" EXPENDABLE POINT W/ O-RING
7	4030305	36645	207680	3.50" SOLID DRIVE POINT
8A	4030056	49145	212290	3.50" HD PULL CAP
8B	4030009	38183	208220	3.50" FLANGE PULL ROD
8C	4030272	37898	208115	3.50" LIFTING SWIVEL PULL CAP, BOX DOWN
9	4020803	38983	208461	3.50" ROD GRIP HANDLE ASSEMBLY (GH40 HAMMER)
10	4020804	44688	210532	3.50" ROD GRIP HANDLE ASSEMBLY (GH60 HAMMER)
11	4020810	44689	210533	3.50" ROD GRIP BODY (GH60 HAMMER)
12	4020308	16792	202948	3.25"/3.50" ROD GRIP HAMMER V-BLOCK (GH60 HAMMER)
13	4030470	12126	201963	3.50" ROD GRIP JAW PAD (GH60 HAMMER)
14	4020316	6370	101149	3.50" ROD GRIP SCREW
15	4020470	9774	201280	3.50" ROD GRIP V-BLOCK RETAINING PIN
16	4020518	27194	600418	3.50" ROD WIPER

# 3.75" PROBE TOOLS

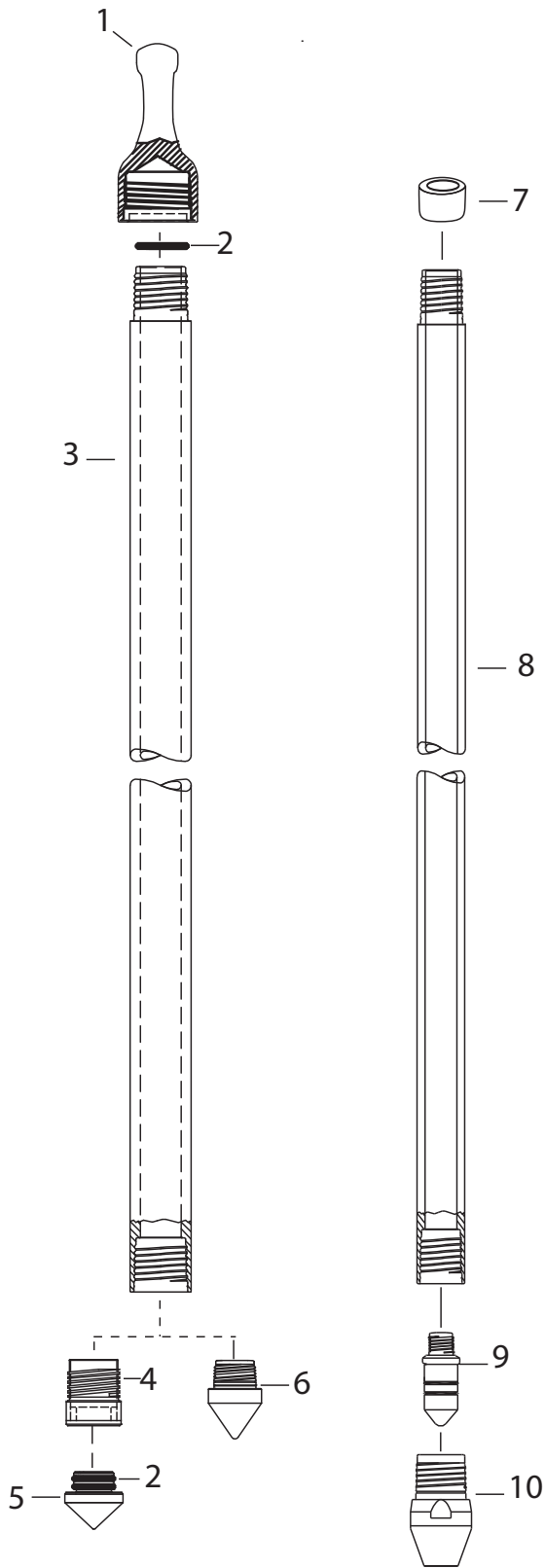

ACCESSORIES		
11A 	11B 	11C 
12 	13 	14 
15 	16 	17 



## 3.75" PROBE TOOLS

3.75" PROBE TOOLS				
ITEM	HP PART #	GP PART #	GP MAT PART #	DESCRIPTION
1	4030453	N/A	219276	3.75" DRIVE CAP, THREADLESS (GH60/80 HAMMER)
2	4030479	N/A	N/A	O-RING, 3.75" PROBE ROD (26/PKG)
3	4030457	N/A	220395	3.75" X 12" PROBE ROD
	4030456	N/A	219278	3.75" X 24" PROBE ROD
	4030459	N/A	N/A	3.75" X 39"/1M PROBE ROD
	4030458	N/A	220539	3.75" X 48" PROBE ROD
	4030462	N/A	219275	3.75" X 60" PROBE ROD
4	4030451	N/A	219559	3.75" EXPENDABLE POINT HOLDER SHORT, (3.75" OD)
5	4030464	N/A	219601	3.75" EXPENDABLE POINT W/ O-RING 4.00" OD
6	4030463	N/A	219277	3.75" SOLID DRIVE POINT
7	4030480	N/A	216256	3.75" SPT CENTERING DRIVE CAP, 2.25"
8	4020323	25351	204777	2.25" X 12" PROBE ROD
	4030244	25300	204766	2.25" X 48" PROBE ROD
	4030245	25301	204767	2.25" X 60" PROBE ROD
9	4030481	N/A	220635	3.75" SPT DRIVE POINT FOR 3.75" RODS (2.25" PIN UP X 2.80" OD)
10	4030482	N/A	219951	3.75" SPT CUTTING SHOE W/ 2.85" BORE FOR 3.75" RODS
11A	4030467	N/A	220535	3.75" PULL CAP
11B	4030469	N/A	220370	3.75" LIFTING SWIVEL PULL CAP, BOX DOWN
11C	4030471	N/A	220730	3.75" FLANGE PULL ROD
12	4030472	N/A	220413	3.75" ROD GRIP HANDLE ASSEMBLY (GH60 HAMMER)
13	4030473	N/A	N/A	3.75" ROD GRIP BODY (GH60 HAMMER)
14	4020308	N/A	N/A	3.75" ROD GRIP HAMMER V-BLOCK (GH60 HAMMER)
15	4030470	12126	201963	3.75" ROD GRIP JAW PAD (GH60 HAMMER)
16	4020316	6370	101149	3.75" ROD GRIP SCREW
17	4030474	N/A	220390	3.75" ROD WIPER

# 4.50" PROBE TOOLS

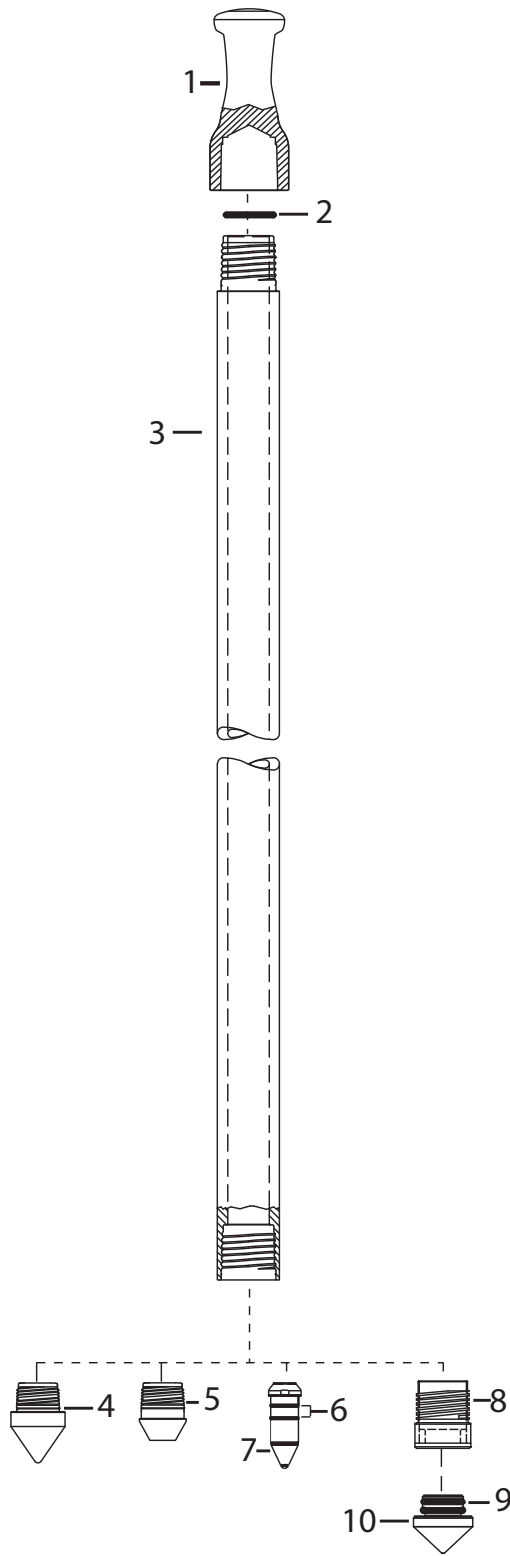

ACCESSORIES		
11A 	11B 	11C 
12 	13 	14 
15 	16 	17 

## 4.50" PROBE TOOLS

4.50" PROBE TOOLS				
ITEM	HP PART #	GP PART #	GP MAT #	DESCRIPTION
1	4020703	26622	205080	4.50" DRIVE CAP, BOX DOWN, THREADLESS (GH60/80 HAMMER)
	4020605	48762	212038	4.50" DRIVE CAP, PIN DOWN, THREADLESS (GH60/80 HAMMER)
2	4030398	34900	104730	O-RING, 4.50" PROBE ROD (25/PKG)
3	4020709	39302	208532	4.50" X 12" PROBE ROD
	4020706	31865	206412	4.50" X 24" PROBE ROD
	4020702	34008	206890	4.50" X 39"/1M PROBE ROD
	4020700	25404	204797	4.50" X 48" PROBE ROD
	4020704	28887	205555	4.50" X 60" PROBE ROD
4	4020815	26925	205120	4.50" SOLID POINT, THREADED (5.00" OD)
	4030369	35999	207515	4.50" SOLID POINT, THREADED (6.00" OD)
5	4030370	30004	205734	4.50" CASING SHOE (3.55" ID, 5.00" OD)
	4030315	35234	207243	4.50" CASING SHOE (3.55" ID, 6.00" OD)
6	4020836	32665	206593	O-RING, 4.50" SOLID DRIVE / DISCRETE POINT (10/PKG)
7	4020838	32663	206592	4.50" SOLID DRIVE / DISCRETE POINT
8	4020710	36574	207649	4.50" EXPENDABLE POINT HOLDER SHORT (4.50" OD)
9	4020708	7702	101467	O-RING, 4.50" EXPENDABLE POINT
10	4020045	36838	207735	4.50" EXPENDABLE POINT W/ O-RING (5.00" OD)
	4020136	39247	208510	4.50" EXPENDABLE POINT W/ O-RING (4.50" OD)
11A	4030067	37343	207873	4.50" HD PULL CAP
11B	4030061	35309	207255	4.50" FLANGE PULL ROD
11C	4020705	29502	205690	4.50" LIFTING SWIVEL PULL CAP, BOX DOWN
12	4020707	31909	206433	4.50" ROD GRIP HANDLE ASSEMBLY (GH60 HAMMER)
13	4020701	32279	206515	4.50" ROD GRIP BODY (GH60 HAMMER)
14	4020506	31690	206336	4.50" ROD GRIP HAMMER V-BLOCK (GH60 HAMMER)
15	4030470	12126	201963	4.50" ROD GRIP JAW PAD (GH60 HAMMER)
16	4020316	6370	101149	4.50" ROD GRIP SCREW
17	4030475	29976	600448	4.50" ROD WIPER



# SOIL SAMPLING SYSTEMS



The **Force** line of Direct Push Tooling includes a complete offering of single rod and dual tube soil sampling systems. Innovative manufacturing techniques coupled with world class raw materials ensure optimum performance, durability, and effective core recovery in a variety of overburden drilling conditions.

## Single Rod Systems:

Single Rod Systems utilize a single rod string to connect the sampling equipment to the rig. After being advanced into the formation to depth, the entire drill string must be retracted to collect the sample. The **Force** offering includes MC5 and MC7 conventional single rod systems offering tried and true simplicity and efficiency.

## Dual Tube Systems:

Dual Tube Systems combine an inner and outer rod string. As the system is advanced into the soil, the soil sample is collected in a sample tube connected to the inner rod string. When at depth, the inner rod string is retracted to collect the sample. The outer rod(s) remain in the ground, thereby serving as a casing for the inner rod string. Dual tube systems offer a number of advantages including preventing cave-ins, sealing off formations from above, and providing the ability to complete a number of additional sampling and monitoring tasks in the borehole. Complete DT22, DT325, DT35, DT37, and DT45 systems are in stock and ready for delivery.

Please contact a **Force** representative for additional details, product availability, or assistance ordering **The Genuine Alternative!**

# MC5 SOIL SAMPLING SYSTEM

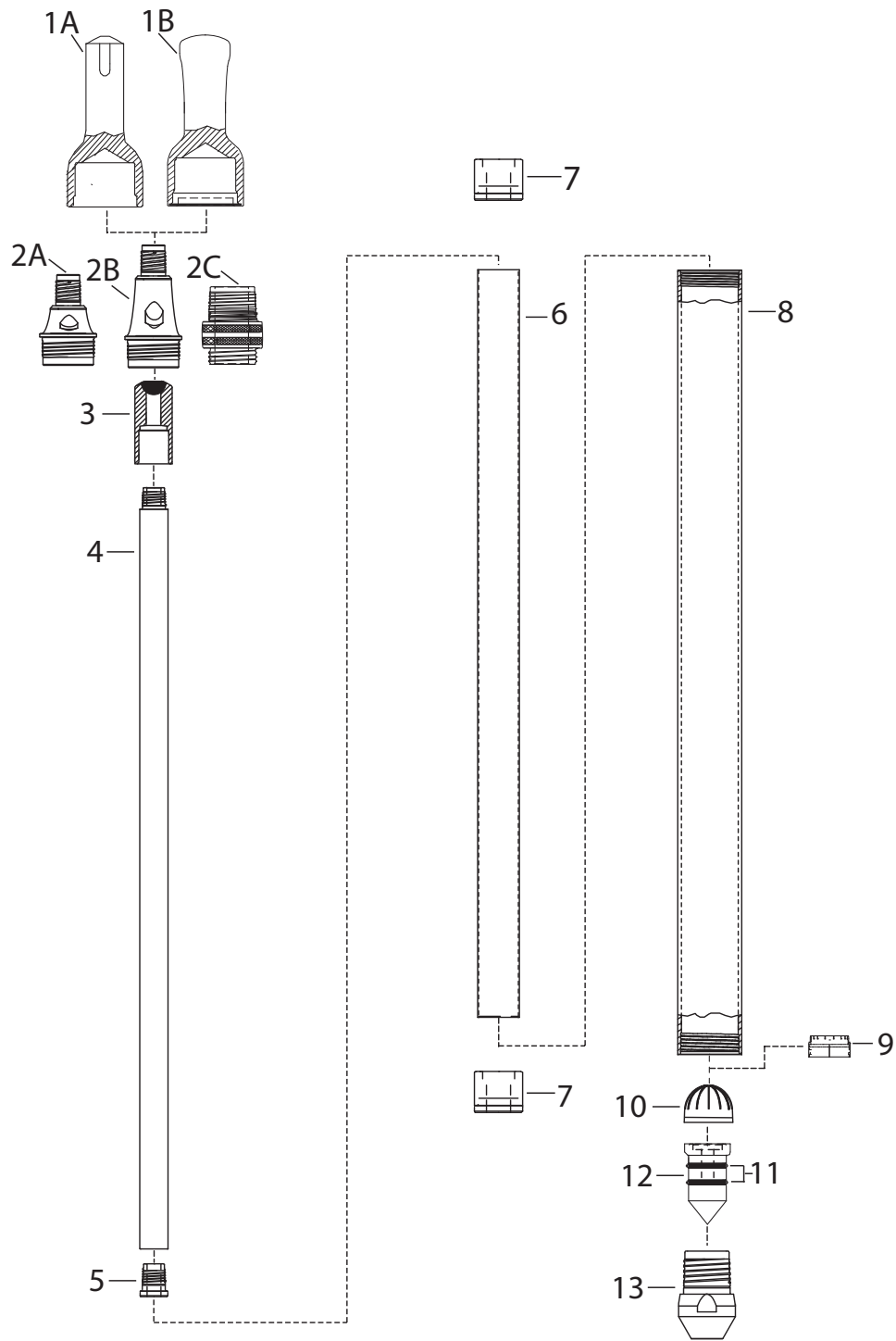

# MC5 SOIL SAMPLING SYSTEM

MC5 SOIL SAMPLING SYSTEM				
ITEM	HP PART #	GP PART #	GP MAT #	DESCRIPTION
1A	4020303	31405	206187	2.25" DRIVE CAP, THREADLESS (GH40 HAMMER)
1B	4030046	31530	206249	2.25" DRIVE CAP, THREADLESS, LONG (GH60 HAMMER)
2A	4030040	26183	205021	MC5 DRIVE HEAD X 1.25" FOR STOP PIN
	4020806	28001	205372	MC5 DRIVE HEAD X 1.25" W/ 1/8" BORE NO STOP PIN
2B	4030042	22990	204257	MC5 DRIVE HEAD X 1.50" FOR STOP PIN
	4030280	27999	205371	MC5 DRIVE HEAD X 1.50" W/ 1/4" BORE NO STOP PIN
2C	4030045	28647	205476	MC5 DRIVE HEAD X 2.25" FOR STOP PIN
	4020812	28646	205475	MC5 DRIVE HEAD X 2.25" W/ 1.375" BORE
3	4030088	23639	204389	MC5 DRIVE CAP FOR CENTER RODS
4	4020227	43012	209949	1.25" X 36" LIGHTWEIGHT PROBE ROD
	4020226	32318	206525	1.25" X 39"/1M LIGHTWEIGHT PROBE ROD
	4030224	21900	203988	1.25" X 48" LIGHTWEIGHT PROBE ROD
	4030277	27600	205232	1.25" X 60" LIGHTWEIGHT PROBE ROD
5	4020800	23641	204390	MC5 CENTER ROD PLUG 1.25" MALE THREAD
6	4020001	AT926K	213873	MC5 LINER CLEAR PVC 24" (66/BOX)
	4020814	AT921K	213872	MC5 LINER CLEAR PVC 36" (66/BOX)
	4020813	AT928K	213874	MC5 LINER CLEAR PVC 39"/1M (66/BOX)
	4020006	AT737K	600984	MC5 LINER CLEAR PVC 48" LIGHT DUTY (66/BOX)
	4020000	AT927K	600993	MC5 LINER CLEAR PVC 48" HEAVY DUTY (66/BOX)
	4020005	10074	600131	MC5 LINER CLEAR PVC 60" (66/BOX)
7	4020026	AT726K	213843	MC5 VINYL LINER CAPS (66/BOX)
8	4020841	24237	215665	MC5 SAMPLER TUBE 24"
	4020829	24238	204550	MC5 SAMPLER TUBE 36"
	4020830	24239	204551	MC5 SAMPLER TUBE 39"/1M
	4030035	22923	204218	MC5 SAMPLER TUBE 48"
	4030030	22992	204259	MC5 SAMPLER TUBE 60"
9	4020013	AT8533K	600988	MC5 LINER SPACER RING (500/PKG)
	4020013	AT8532K	213857	MC5 LINER SPACER RING (66/PKG)
10*	4020016	AT8534K	600989	MC5 CORE CATCHER (100/BOX)
	4020016	AT8531K	213856	MC5 CORE CATCHER (28/BOX)
11	4020009	DT4070R	213918	O-RING, MC5 PISTON POINT
12	4030079	28113	205387	MC5 PISTON POINT CLOSED STANDARD SIZE 1.50" OD W/ O-RING
	4030080	26865	205113	MC5 PISTON POINT CLOSED UNDER SIZED 1.35" OD W/ O-RINGS
13	4030062	26078	204985	MC5 CUTTING SHOE 1.25" ID W/ EXTENDED SHANK (2.375" OD)
	4020060	29552	205705	MC5 CUTTING SHOE 1.35" ID W/ STANDARD SHANK (2.375" OD)
	4030068	32035	206460	MC5 CUTTING SHOE 1.35" ID W/ EXTENDED SHANK (2.30" OD)
	4030060	22922	204217	MC5 CUTTING SHOE 1.50" ID W/ STANDARD SHANK (2.30" OD)
	4030070	23978	204500	MC5 CUTTING SHOE 1.50" ID W/ EXTENDED SHANK (2.375" OD)
	4030071	32490	206560	MC5 CUTTING SHOE W/ MC5 THREAD, STANDARD SHANK (2.25" OD)

# MC5 TOOLING & ACCESSORIES

## MC5 PISTON RODS

MC5 PISTON RODS			
HP PART #	GP PART #	GP MAT #	DESCRIPTION
4020825	10729	N/A	MC5 PISTON ROD 24"
4020826	10728	N/A	MC5 PISTON ROD 36"
4020824	10732	N/A	MC5 PISTON ROD 39"/1M
4030274	9038	201183	MC5 PISTON ROD 48"
4030281	10727	201470	MC5 PISTON ROD 60"

## MC5 LINERS

MC5 LINERS * (None Stock: Special Order Only)			
HP PART #	GP PART #	GP MAT #	DESCRIPTION
4020816	5131	200596	MC5 LINER CLEAR TEFLON 48"
4020004	38752	219147	MC5 LINER CLEAR TEFLON 60"
4020820	AT7235	213840	MC5 LINER SS 48"
4020821	16315	202873	MC5 LINER SS 60"
4020822	7332	N/A	MC5 LINER SS LONG SECTION
4020823	7333	N/A	MC5 LINER SS SHORT SECTION

\*Liner cutters available on request.

## MC5 MISCELLANEOUS TOOLS

MC5 ACCESSORIES AND MISCELLANEOUS TOOLS*			
HP PART #	GP PART #	GP MAT #	DESCRIPTION
4020839	9016	201179	MC5 STOP PIN COUPLER
4030452	9754	201276	MC QUICK LINKS STOP PIN REMOVER
4020811	N/A	N/A	MC5 DRIVE HEAD X AWJ BOX FOR STOP PIN
4020831	19520	203559	MC5 PLUNGER FOR HYDRAULIC LINER
4020828	29532	205697	MC5 ADAPTER FOR HYDRAULIC EXTRUDER
4020832	BU700	601003	MC5 NYLON BRUSH
4020837	29919	205731	MC5 CUTTING SHOE (2.25" OD) EXT SHANK
4030039	AT633	600977	TAP, 9/16" REVERSE THREAD
4030105	15527	202723	MC/MC5 STOP PIN FOR 1.50" DRIVE HEAD
4020840	10069	201349	MC/MC5 STOP PIN FOR 1.25" & 2.25" DRIVE HEADS
4030435	AT6312R	213812	O-RING, MC5 STOP PINS (25/PKG)

\*See page 49 for Extension Rods.





# MC7 SOIL SAMPLING SYSTEM

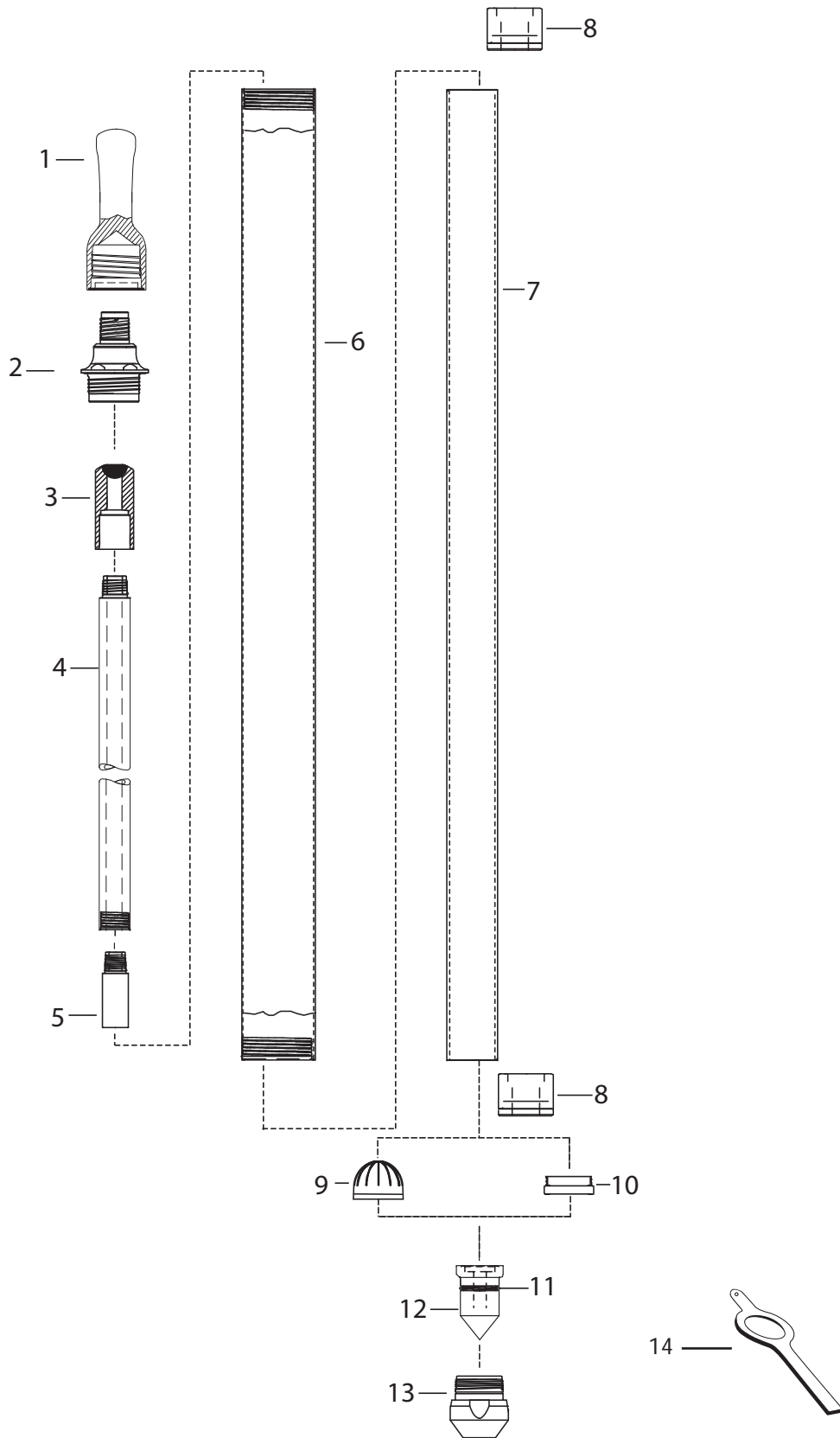

# MC7 SOIL SAMPLING SYSTEM

MC7 SOIL SAMPLING SYSTEM				
ITEM	HP PART #	GP PART #	GP MAT #	DESCRIPTION
1	4030046	31530	206249	2.25" DRIVE CAP, THREADLESS, LONG (GH60 HAMMER)
2	4020900	48423	211889	MC7 DRIVE HEAD W/ 2.25" PIN
3	4030088	23639	204389	MC5 DRIVE CAP FOR CENTER RODS
4	4030279	AT1212	213753	1.25" X 12" CENTER PROBE ROD
	4030270	AT1248	213769	1.25" X 48" CENTER PROBE ROD
	4030267	AT1260	213773	1.25" X 60" CENTER PROBE ROD
5	4020901	N/A	216119	MC7 CENTER ROD SPACER
6	4020904	N/A	216883	MC7 SAMPLE SHEATH 48"
	4020903	48302	211838	MC7 SAMPLE SHEATH 60"
	4020902	N/A	216885	MC7 SAMPLE SHEATH 72"
7	4020107	46125	600721	DT45 LINER CLEAR PVC 48" (18/BOX)
	4020105	46065	600719	DT45 LINER CLEAR PVC 60" (18/BOX)
	4030390	46066	600720	DT45 LINER CLEAR PVC 72" (18/BOX)
8	4020113	35806	207439	MC7/DT45 VINYL LINER CAPS
9*	4020906	34454	207000	MC7/DT45 CORE CATCHER
10	4020905	45603	210856	MC7 CORE CATCHER SPACER RING
11	4030044	19743	102981	O-RING, MC7 PISTON POINT
12	4020907	N/A	218055	MC7 PISTON POINT W/ O-RING
13	4020908	N/A	216121	MC7 SHOE CUTTING
14	4020909	30302	205773	MC7 CUTTING SHOE WRENCH / DT45 RETAINER WRENCH

# DT22 SOIL SAMPLING SYSTEM

CONVENTIONAL DUAL TUBE CONFIGURATION

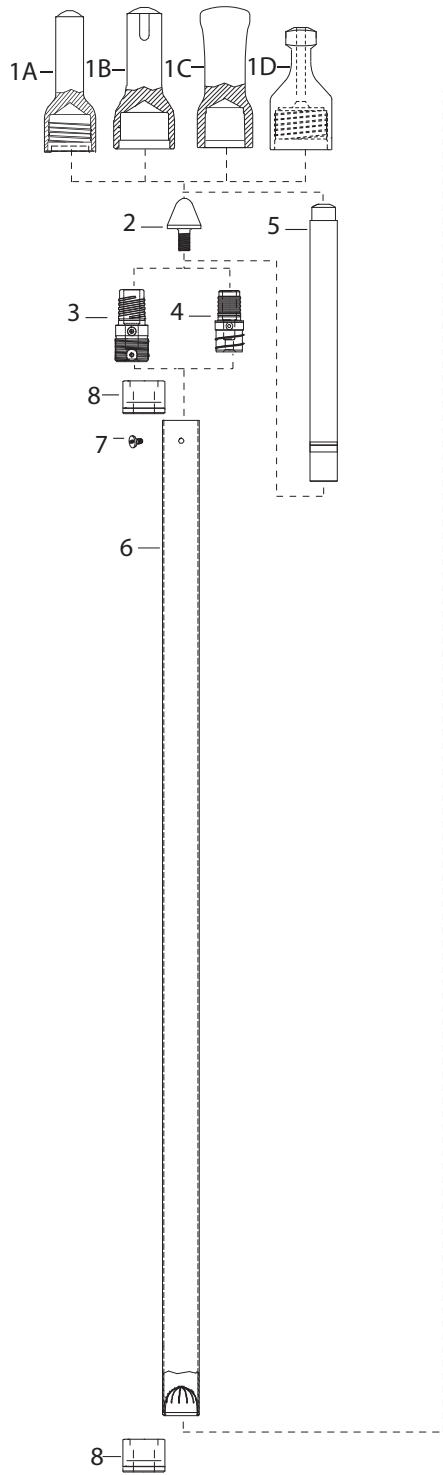

CONVENTIONAL DISCRETE POINT CONFIGURATION

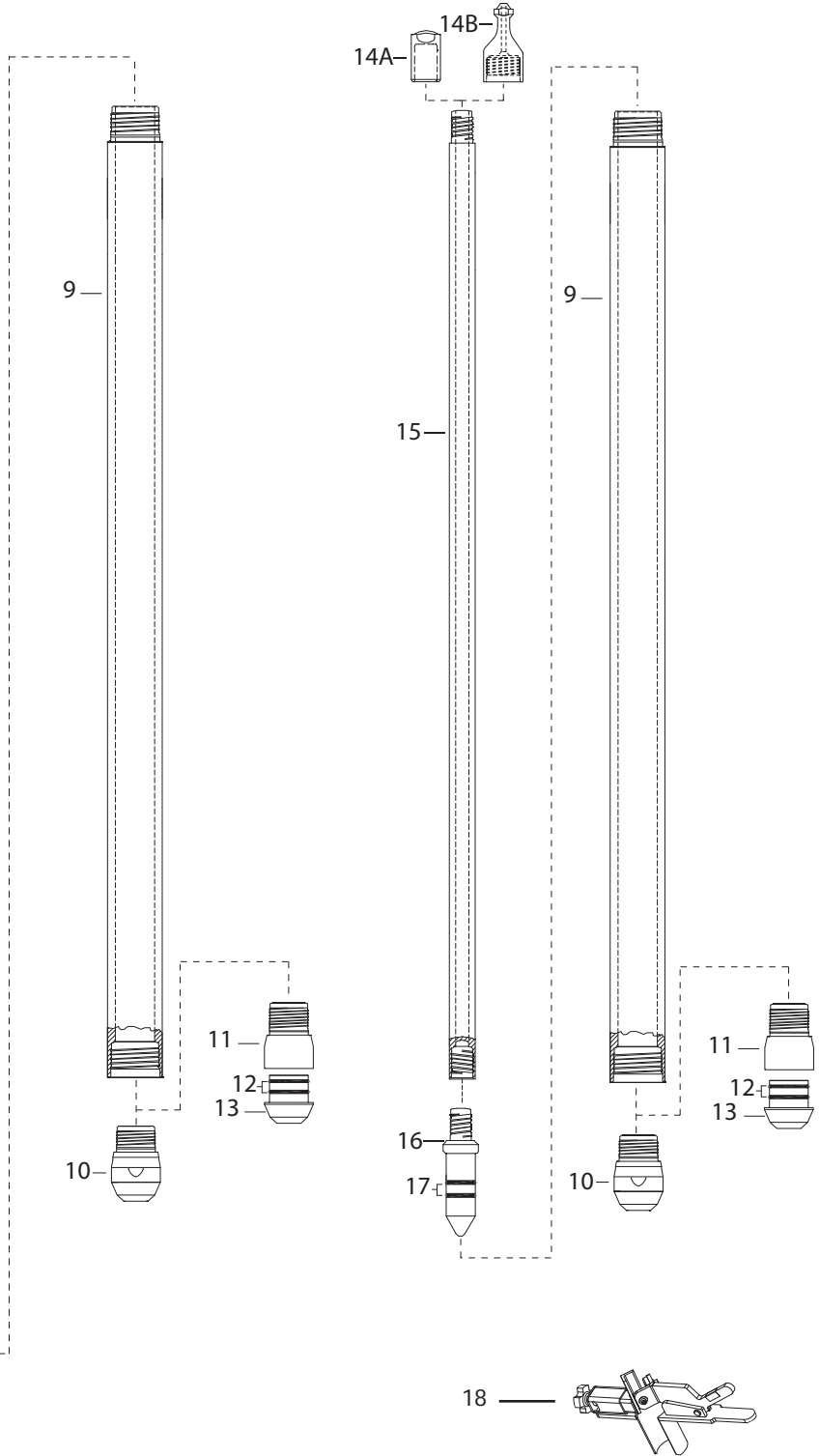

# DT22 SOIL SAMPLING SYSTEM

DT22 SOIL SAMPLING SYSTEM				
ITEM	HP PART #	GP PART #	GP MAT #	DESCRIPTION
1A	4020304	25362	204787	2.25" DRIVE CAP, W/ THREADS (GH40 HAMMER)
1B	4020303	31405	206187	2.25" DRIVE CAP, THREADLESS (GH40 HAMMER)
1C	4030046	31530	206249	2.25" DRIVE CAP, THREADLESS, LONG (GH60 HAMMER)
1D	4020326	33622	206823	2.25" PULL CAP HD
2	4020175	DT4010	601006	DT22 DRIVE BUMPER, RUBBER
3	4030038	DT4052	213916	DT22 DRIVE HEAD FOR LINERS W/ 1.25" MALE THREAD UP
4	4030350	41675	209428	DT22 THREAD CUTTING DRIVE HEAD (FISHING TOOL)
5	4020802	49852	212548	DT22 CUSHION ASSEMBLY
6	4020127	DT4024K	N/A	DT22 LINER 24" W/O INTEGRAL CORE CATCHER (50/BOX)
	4020129	DT4036K	213910	DT22 LINER 36" W/O INTEGRAL CORE CATCHER (50/BOX)
	4020125	DT4039K	213911	DT22 LINER 39"/1M W/O INTEGRAL CORE CATCHER (50/BOX)
	4020146	DT4048K	213914	DT22 LINER 48" W/O INTEGRAL CORE CATCHER (50/BOX)
	4020008	DT4061K	213917	DT22 LINER 60" W/O INTEGRAL CORE CATCHER (50/BOX)
	4020126	DT4124K	N/A	DT22 LINER 24" W/ INTEGRAL CORE CATCHER (50/BOX)
	4020128	DT4136K	213919	DT22 LINER 36" W/ INTEGRAL CORE CATCHER (50/BOX)
	4020124	DT4139K	213920	DT22 LINER 39"/1M W/ INTEGRAL CORE CATCHER (50/BOX)
	4020147	DT4148K	213922	DT22 LINER 48" W/ INTEGRAL CORE CATCHER (50/BOX)
	4020007	DT4161K	213924	DT22 LINER 60" W/ INTEGRAL CORE CATCHER (50/BOX)
7	4020121	13162	202221	DT22 BOLT FOR LINER DRIVE HEAD (20/PKG)
8	4020150	DT4026K	213909	DT22 VINYL LINER CAPS
9	4020323	25351	204777	2.25" X 12" PROBE ROD
	4030242	32656	206588	2.25" X 24" PROBE ROD
	4020324	33245	206706	2.25" X 36" PROBE ROD
	4020325	25352	204778	2.25" X 39"/1M PROBE ROD
	4030244	25300	204766	2.25" X 48" PROBE ROD
	4030245	25301	204767	2.25" X 60" PROBE ROD
10	4030072	25341	204774	DT22 SHOE STANDARD SIZE 2.375" OD X 1.125" ID
11	4030093	50271	212678	DT22 HOLDER FOR EXPENDABLE SHOES
	4030095	43128	209991	DT22 HOLDER FOR 1.625" OD EXPENDABLE POINTS
12	4020011	DT4045R	213913	O-RING, EXPENDABLE CUTTING SHOE (50/PKG)
13	4020307	50726	215278	DT22 EXPENDABLE CUTTING SHOE (2.375" OD) W/ O-RINGS
14A	4030043	22955	204236	DT22 DRIVE CAP 1.25" THREADLESS
14B	4030059	AT1204	213751	1.25" PULL CAP
15	4020227	43012	209949	1.25" X 36" LIGHTWEIGHT PROBE ROD
	4020226	32318	206525	1.25" X 39"/1M LIGHTWEIGHT PROBE ROD
	4030224	21900	203988	1.25" X 48" LIGHTWEIGHT PROBE ROD
	4030277	27600	205232	1.25" X 60" LIGHTWEIGHT PROBE ROD
16	4030278	22956	204237	DT22 DISCRETE POINT FOR USE W/ 1.25" INNER RODS
17	4020009	DT4070R	213918	O-RING, DT22 DISCRETE POINT (25/PKG)
18	4020103	27216	205182	ADJUSTABLE CENTER ROD CLAMP FOR 1.25" RODS
*	4020058	DT4051K	213915	DT22 REBUILD KIT FOR LINER DRIVE HEAD

\* Rebuild kit not shown.

# DT325 SOIL SAMPLING SYSTEM

CONVENTIONAL DUAL TUBE CONFIGURATION

CONVENTIONAL DISCRETE POINT CONFIGURATION

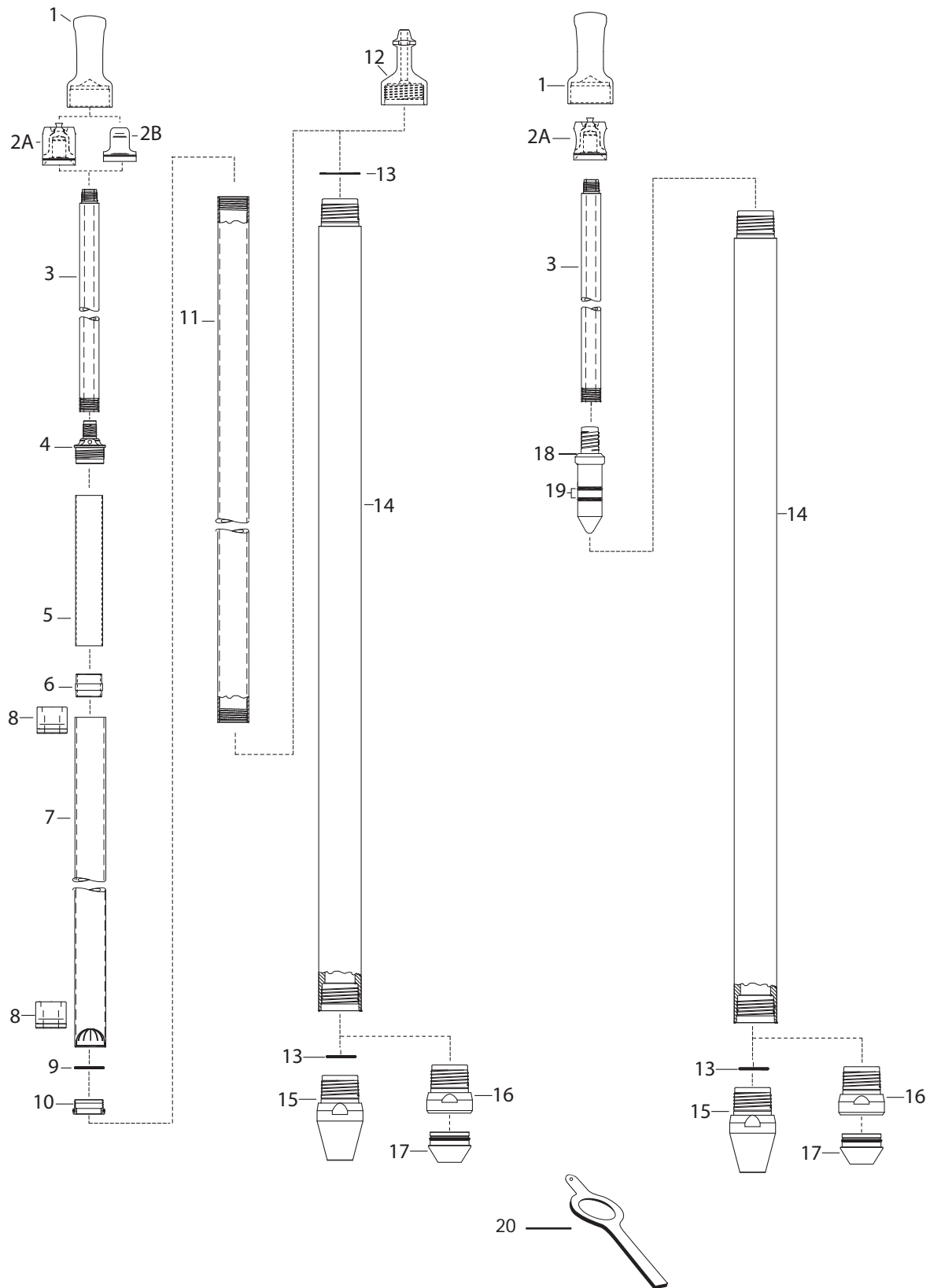

# DT325 SOIL SAMPLING SYSTEM

DT325 SOIL SAMPLING SYSTEM				
ITEM	HP PART #	GP PART #	GP MAT #	DESCRIPTION
1	4030049	9742	201275	3.25" DRIVE CAP, THREADLESS (GH60 HAMMER)
2A	4030318	37708	208053	DT325 BUFFERING DRIVE CAP
2B	4030268	12943	202145	DT325 CENTERING DRIVE CAP
3	4030279	AT1212	213753	1.25" X 12" PROBE ROD
	4020230	AT1239	213763	1.25" X 39"/1M PROBE ROD
	4030270	AT1248	213769	1.25" X 48" PROBE ROD
	4030267	AT1260	213773	1.25" X 60" PROBE ROD
	4020226	32318	206525	1.25" X 39"/1M LIGHTWEIGHT PROBE ROD
	4030224	21900	203988	1.25" X 48" LIGHTWEIGHT PROBE ROD
	4030277	27600	205232	1.25" X 60" LIGHTWEIGHT PROBE ROD
4	4030338	10212	201385	DT325/DT35/DT37 DRIVE HEAD FOR SAMPLER SHEATH W/ 1.25" THREAD
5	4030346	29609	600443	DT325/DT35/DT37 LINER SPACER 11.50" REFILL
6	4030368	29358	205663	DT325/DT35/DT37 LINER SPACER CONNECTOR
7	4030348	27815	600424	DT325/DT35/DT37 LINER 39"/1M W/ CORE CATCHER (42/BOX)
	4020108	27814	600423	DT325/DT35/DT37 LINER 48" W/ CORE CATCHER (42/BOX)
	4020100	27813	600422	DT325/DT35/DT37 LINER 60" W/ CORE CATCHER (42/BOX)
	4020109	DT3248K	601004	DT325/DT35/DT37 LINER 48" W/O CORE CATCHER (42/BOX)
	4020101	DT3260K	601005	DT325/DT35/DT37 LINER 60" W/O CORE CATCHER (42/BOX)
8	4020112	17762	600232	DT325/DT35/DT37 VINYL LINER CAPS
9	4030352	28379	600428	O-RING, DT325 LINER RETAINER (25/PKG)
10	4030342	26718	205098	DT325/DT35/DT37 LINER RETAINER W/ GROOVE
	4030269	39011	208472	DT325/DT35/DT37 LINER RETAINER, HEAVY DUTY
11	4030358	27712	205265	DT325/DT35/DT37 SAMPLER SHEATH 39"/1M
	4030360	27711	205264	DT325/DT35/DT37 SAMPLER SHEATH 48"
	4030362	26719	205099	DT325/DT35/DT37 SAMPLER SHEATH 60"
	4030364	26805	205110	DT325/DT35/DT37 SAMPLER SHEATH 72"
12	4030050	13257	202234	3.25" PULL CAP
13	4020514	9960	201325	O-RING, DT325/DT35 CUTTING SHOE & PROBE ROD
14	4020508	13672	202313	3.25" X 12" PROBE ROD
	4020510	13925	202363	3.25" X 39"/1M PROBE ROD
	4020511	10594	201446	3.25" X 48" PROBE ROD
	4030250	9040	201185	3.25" X 60" PROBE ROD
15	4030322	26720	205100	DT325 CUTTING SHOE 1.75" ID X 3.450" OD
	4030077	28508	205449	DT325 CUTTING SHOE 1.85" ID
16	4030320	28339	205424	DT325 HOLDER FOR EXPENDABLE CUTTING SHOE
17	4030366	28341	205426	DT325/DT35/DT37 EXPENDABLE CUTTING SHOE (1.75" ID)
18	4030271	28509	205450	DT325/DT35 DISCRETE POINT 1.85" OD W/ 1.25" PIN UP
	4030336	27763	205279	DT325/DT35 DISCRETE POINT 1.75" OD W/ 1.25" PIN UP
19	4030356	13942	202366	O-RING, FOR DT325/DT35 DISCRETE POINT (25/PKG)
20	4030344	27838	205299	DT325/DT35 RETAINER WRENCH

# DT35 SOIL SAMPLING SYSTEM

CONVENTIONAL DUAL TUBE CONFIGURATION

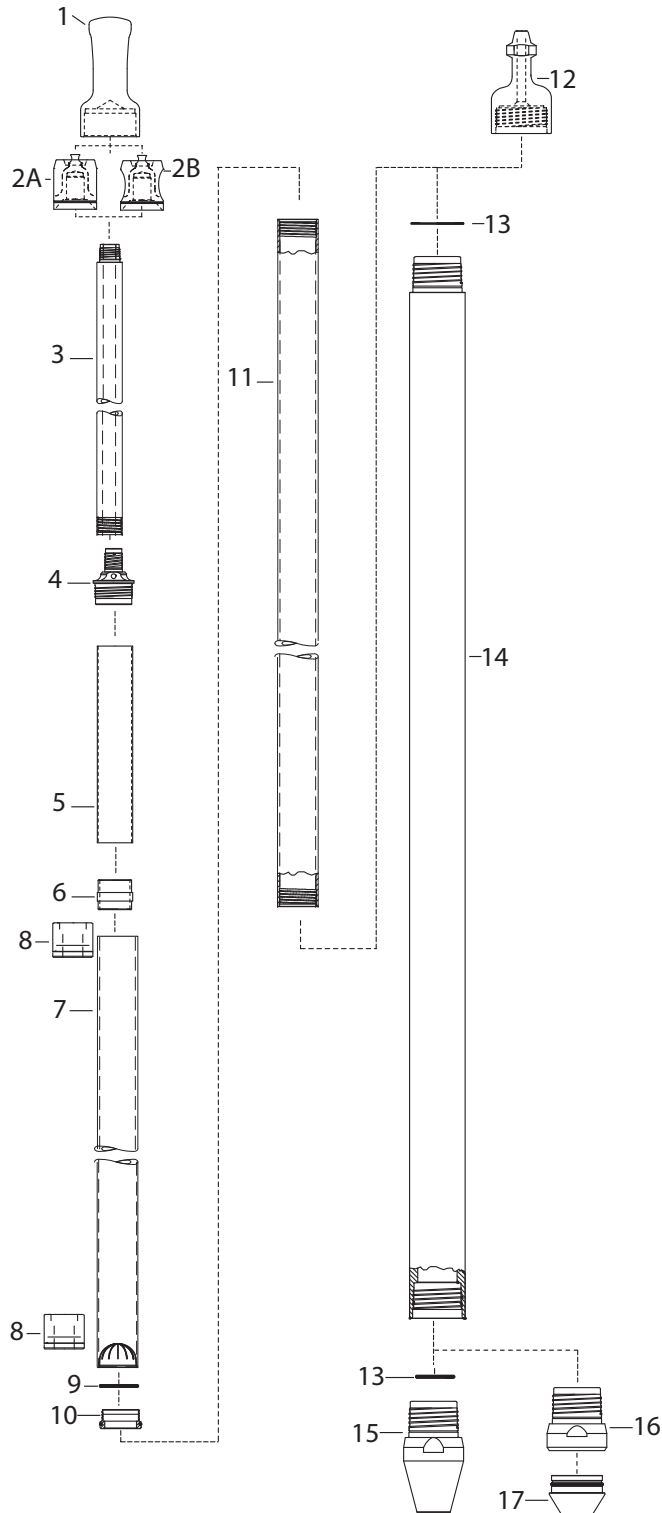

CONVENTIONAL DISCRETE POINT CONFIGURATION

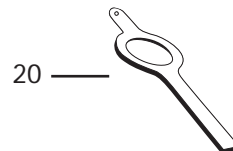
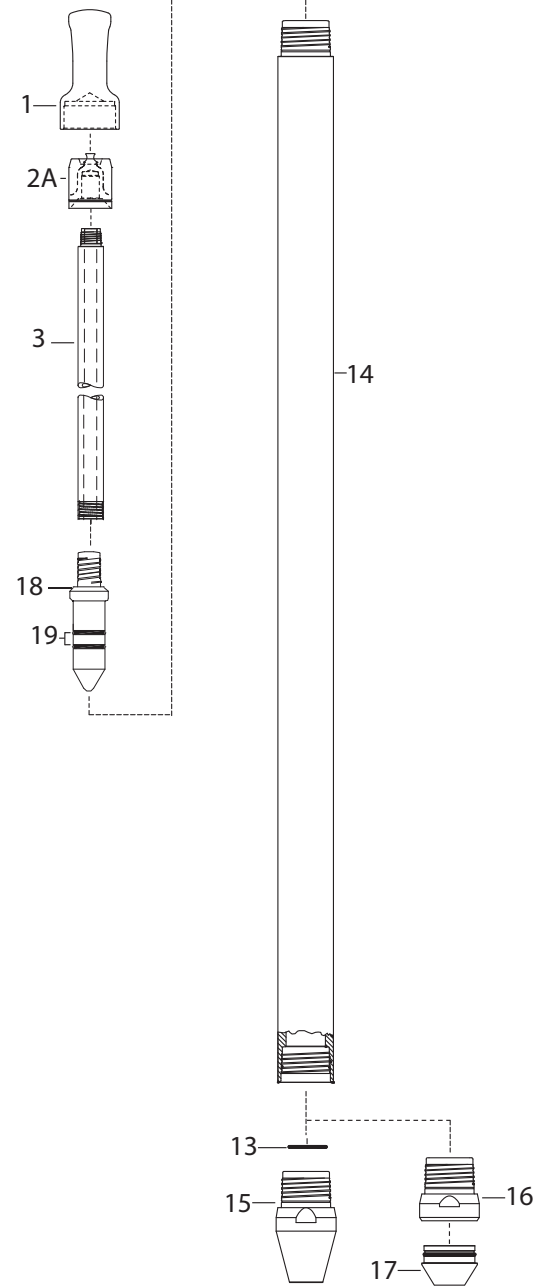



# DT35 SOIL SAMPLING SYSTEM

DT35 SOIL SAMPLING SYSTEM				
ITEM	HP PART #	GP PART #	GP MAT #	DESCRIPTION
1	4030057	36642	207679	3.50" DRIVE CAP, THREADLESS (GH60/80 HAMMER)
2A	4030326	43239	210051	DT35/DT37 BUFFERING DRIVE CAP
	4030328	43240	210052	DT35/DT37 BUFFERING DRIVE CAP, HEAVY DUTY
2B	4030330	38381	208259	DT35/DT37 CENTERING DRIVE CAP
3	4020230	AT1239	213763	1.25" X 39"/1M PROBE ROD
	4030270	AT1248	213769	1.25" X 48" PROBE ROD
	4030267	AT1260	213773	1.25" X 60" PROBE ROD
	4020226	32318	206525	1.25" X 39"/1M LIGHTWEIGHT PROBE ROD
	4030224	21900	203988	1.25" X 48" LIGHTWEIGHT PROBE ROD
	4030277	27600	205232	1.25" X 60" LIGHTWEIGHT PROBE ROD
4	4030338	10212	201385	DT325/DT35/DT37 DRIVE HEAD FOR SAMPLER SHEATH W/ 1.25" THREAD
5	4030346	29609	600443	DT325/DT35/DT37 LINER SPACER 11.50" REFILL
6	4030368	29358	205663	DT325/DT35/DT37 LINER SPACER CONNECTOR
7	4030348	27815	600424	DT325/DT35/DT37 LINER 39"/1M W/ CORE CATCHER (42/BOX)
	4020108	27814	600423	DT325/DT35/DT37 LINER 48" W/ CORE CATCHER (42/BOX)
	4020100	27813	600422	DT325/DT35/DT37 LINER 60" W/ CORE CATCHER (42/BOX)
	4020109	DT3248K	601004	DT325/DT35/DT37 LINER 48" W/O CORE CATCHER (42/BOX)
	4020101	DT3260K	601005	DT325/DT35/DT37 LINER 60" W/O CORE CATCHER (42/BOX)
8	4020112	17762	600232	DT325/DT35/DT37 VINYL LINER CAPS
9	4030352	28379	600428	O-RING, DT35 LINER RETAINER (25/PKG)
10	4030342	26718	205098	DT325/DT35/DT37 LINER RETAINER W/ GROOVE
	4030269	39011	208472	DT325/DT35/DT37 LINER RETAINER, HEAVY DUTY
11	4030358	27712	205265	DT325/DT35/DT37 SAMPLER SHEATH 39"/1M
	4030360	27711	205264	DT325/DT35/DT37 SAMPLER SHEATH 48"
	4030362	26719	205099	DT325/DT35/DT37 SAMPLER SHEATH 60"
	4030364	26805	205110	DT325/DT35/DT37 SAMPLER SHEATH 72"
12	4030056	49145	212290	DT35 3.50" PULL CAP
13	4020514	9960	201325	O-RING, DT325/DT35 CUTTING SHOE & PROBE ROD
14	4030266	38173	208219	3.50" X 24" PROBE ROD
	4020603	38952	214781	3.50" X 39"/1M PROBE ROD
	4030264	38951	208446	3.50" X 48" PROBE ROD
	4030265	36641	215664	3.50" X 60" PROBE ROD
15	4030076	37758	208066	DT35 CUTTING SHOE STANDARD 1.85" ID X 3.75" OD
	4030334	39178	208502	DT35 CUTTING SHOE 1.85" ID x 3.50" OD
16	4030332	36815	207726	DT35 HOLDER FOR EXPENDABLE CUTTING SHOES
17	4030366	28341	205426	DT325/DT35/DT37 EXPENDABLE CUTTING SHOE (1.75" ID)
18	4030271	28509	205450	DT325/DT35 DISCRETE POINT 1.85" OD W/ 1.25" PIN UP
	4030336	27763	205279	DT325/DT35 DISCRETE POINT 1.75" OD W/ 1.25" PIN UP
19	4030356	13942	202366	O-RING, FOR DT325/DT35 DISCRETE POINT (25/PKG)
20	4030344	27838	205299	DT325/DT35 RETAINER WRENCH

# DT37 SOIL SAMPLING SYSTEM

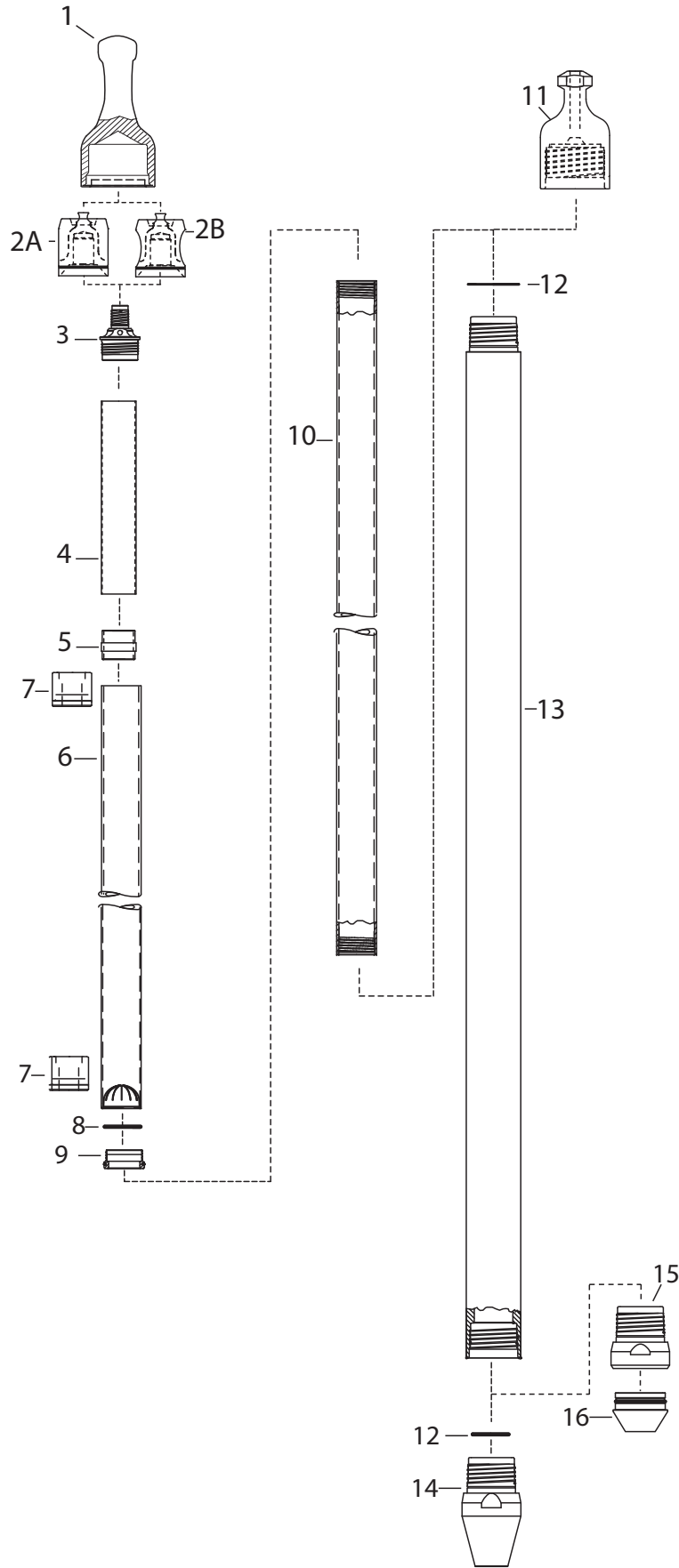

# DT37 SOIL SAMPLING SYSTEM

DT37 SOIL SAMPLING SYSTEM				
ITEM	HP PART #	GP PART #	GP MAT #	DESCRIPTION
1	4030453	N/A	219276	3.75" DRIVE CAP, THREADLESS (GH60/80 HAMMER)
2A	4030326	43239	210051	DT35/DT37 BUFFERING DRIVE CAP
	4030328	43240	210052	DT35/DT37 BUFFERING DRIVE CAP, HEAVY DUTY
2B	4030330	38381	208259	DT35/DT37 CENTERING DRIVE CAP
3	4030338	10212	201385	DT325/DT35/DT37 DRIVE HEAD FOR SAMPLER SHEATH W/ 1.25" THREAD
4	4030346	29609	600443	DT325/DT35/DT37 LINER SPACER 11.50" REFILL
5	4030368	29358	205663	DT325/DT35/DT37 LINER SPACER CONNECTOR
6	4030348	27815	600424	DT325/DT35/DT37 LINER 39"/1M W/ CORE CATCHER (42/BOX)
	4020108	27814	600423	DT325/DT35/DT37 LINER 48" W/ CORE CATCHER (42/BOX)
	4020100	27813	600422	DT325/DT35/DT37 LINER 60" W/ CORE CATCHER (42/BOX)
	4020109	DT3248K	601004	DT325/DT35/DT37 LINER 48" W/O CORE CATCHER (42/BOX)
	4020101	DT3260K	601005	DT325/DT35/DT37 LINER 60" W/O CORE CATCHER (42/BOX)
7	4020112	17762	600232	DT325/DT35/DT37 VINYL LINER CAPS
8	4030352	28379	600428	O-RING, DT37 LINER RETAINER (25/PKG)
9	4030342	26718	205098	DT325/DT35/DT37 LINER RETAINER W/ GROOVE
	4030269	39011	208472	DT325/DT35/DT37 LINER RETAINER, HEAVY DUTY
10	4030358	27712	205265	DT325/DT35/DT37 SAMPLER SHEATH 39"/1M
	4030360	27711	205264	DT325/DT35/DT37 SAMPLER SHEATH 48"
	4030362	26719	205099	DT325/DT35/DT37 SAMPLER SHEATH 60"
	4030364	26805	205110	DT325/DT35/DT37 SAMPLER SHEATH 72"
11	4030467	N/A	220535	DT37 3.5 PULL CAP
12	4030479	N/A	N/A	O-RING, DT37 CUTTING SHOE & PROBE ROD
13	4030457	N/A	220395	3.75" X 12" PROBE ROD
	4030456	N/A	219278	3.75" X 24" PROBE ROD
	4030459	N/A	N/A	3.75" X 39"/1M PROBE ROD
	4030458	N/A	220539	3.75" X 48" PROBE ROD
	4030462	N/A	219275	3.75" X 60" PROBE ROD
14	4030483	N/A	219582	DT37 CUTTING SHOE
15	4030484	N/A	219620	DT37 HOLDER FOR EXPENDABLE CUTTING SHOES
16	4030366	28341	205426	DT325/DT35/DT37 EXPENDABLE CUTTING SHOE (1.75" ID)

# DT45 SOIL SAMPLING SYSTEM

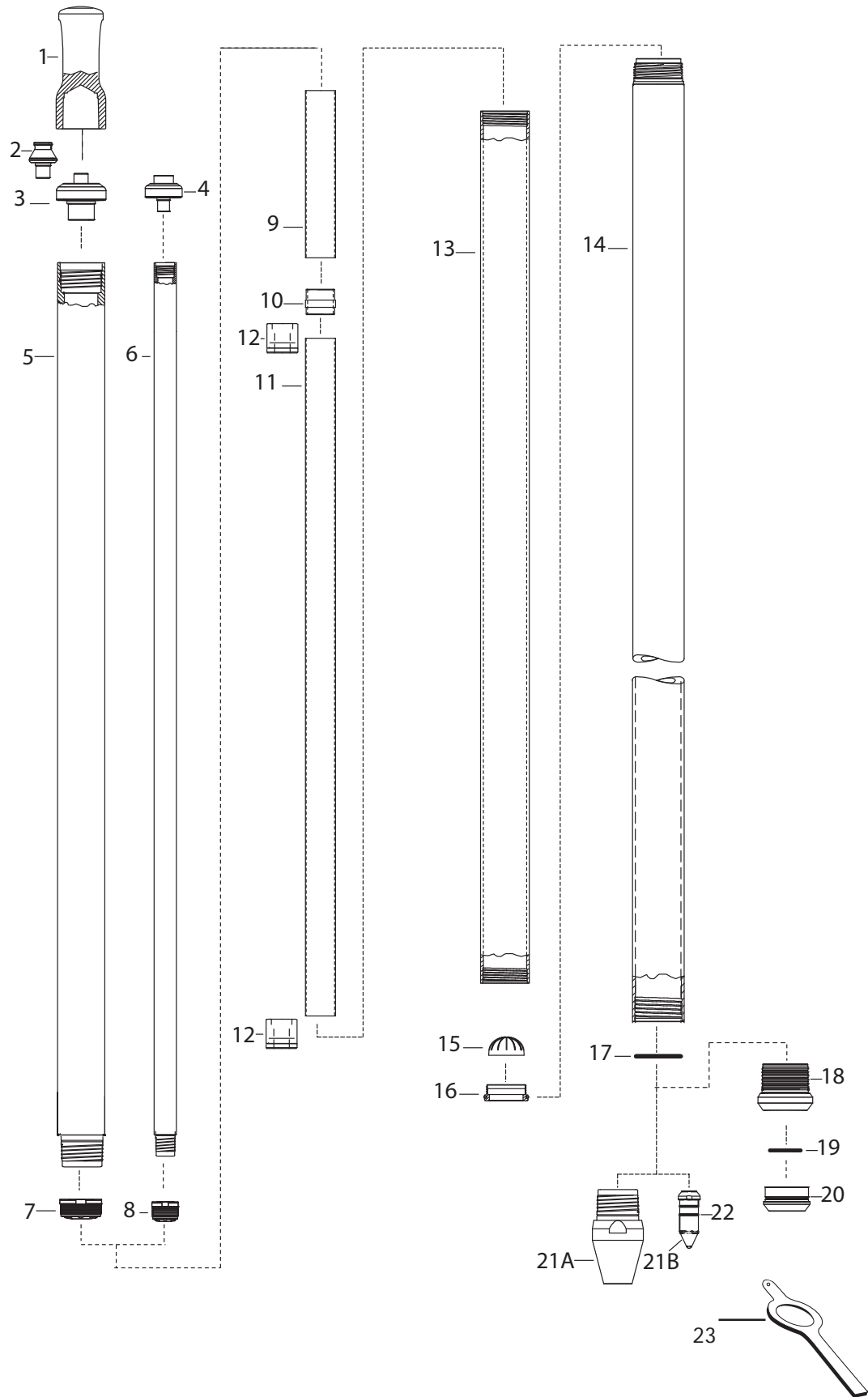

# DT45 SOIL SAMPLING SYSTEM

DT45 SOIL SAMPLING SYSTEM				
ITEM	HP PART #	GP PART #	GP MAT #	DESCRIPTION
1	4020703	26622	205080	4.50" DRIVE CAP, BOX DOWN, THREADLESS (GH60/80 HAMMER)
2	4030420	32381	206538	DT45 CENTERING DRIVE CAP 2.25" ROD
3	4030382	32694	206602	DT45 BUFFERING DRIVE CAP 2.25" ROD
4	4030380	32693	206601	DT45 BUFFERING DRIVE CAP 1.25" RODS
5	4020323	25351	204777	2.25" X 12" PROBE ROD
	4030242	32656	206588	2.25" X 24" PROBE ROD
	4020324	33245	206706	2.25" X 36" PROBE ROD
	4020325	25352	204778	2.25" X 39"/1M PROBE ROD
	4030244	25300	204766	2.25" X 48" PROBE ROD
	4030245	25301	204767	2.25" X 60" PROBE ROD
6	4030279	AT1212	213753	1.25" X 12" PROBE ROD
	4030222	AT1224	213758	1.25" X 24" PROBE ROD
	4020229	AT1236	213762	1.25" X 36" PROBE ROD
	4020230	AT1239	213763	1.25" X 39"/1M PROBE ROD
	4030270	AT1248	213769	1.25" X 48" PROBE ROD
	4030267	AT1260	213773	1.25" X 60" PROBE ROD
7	4030386	32335	206527	DT45 DRIVE HEAD FOR 2.25" CENTER RODS
8	4030384	30289	205770	DT45 DRIVE HEAD FOR 1.25" CENTER RODS
9	4030396	32526	600484	DT45 LINER SPACER 12"
10	4030392	30436	205797	DT45 LINER SPACER CONNECTOR
11	4020107	46125	600721	DT45 LINER CLEAR PVC 48"
	4020105	46065	600719	DT45 LINER CLEAR PVC 60"
	4030390	46066	600720	DT45 LINER CLEAR PVC 72"
12	4020113	35806	207439	DT45/MC7 VINYL LINER CAPS
13	4030408	34081	206898	DT45 SAMPLE TUBE 39"/1M
	4030410	30248	205760	DT45 SAMPLE TUBE 48"
	4030412	30250	205761	DT45 SAMPLE TUBE 60"
	4030414	30252	205762	DT45 SAMPLE TUBE 72"
14	4020709	39302	208532	4.50" X 12" PROBE ROD
	4020706	31865	206412	4.50" X 24" PROBE ROD
	4020702	34008	206890	4.50" X 39"/1M PROBE ROD
	4020700	25404	204797	4.50" X 48" PROBE ROD
	4020704	28887	205555	4.50" X 60" PROBE ROD
15*	4020906	34454	207000	DT45/MC7 CORE CATCHER
16	4030406	32349	206531	DT45 LINER RETAINER
17	4030398	34900	104730	O-RING, DT45 PROBE ROD
18	4030388	32940	206638	DT45 EXPENDABLE CUTTING SHOE HOLDER 4.50" OD (3.75 ID)
19	4030400	34888	600528	O-RING, DT45 EXPENDABLE CUTTING SHOE
20	4030418	34887	207105	DT45 EXPENDABLE CUTTING SHOE
21A	4030416	30450	205800	DT45 CUTTING SHOE
21B	4030404	34086	206901	DT45 SOLID DRIVE / DISCRETE POINT (2.25" BOX UP)
22	4030402	9751	101901	O-RING, DT45 SOLID DRIVE POINT
23	4020909	30302	205773	DT45 RETAINER WRENCH



## GROUNDWATER SAMPLING & ASSESSMENT SYSTEMS



**Force DPT** offers groundwater sampling systems designed to economically and effectively obtain groundwater samples in unconsolidated formations, thus allowing the groundwater to be assessed for potential contamination during environmental site investigations.

The **Force SP16 and SP22** samplers are used in temporary installations to allow for quick discrete water sample collection. Upon completion of sampling activities these systems are extracted from the subsurface formation and reused for subsequent sampling events.

For small diameter monitoring well installations, **Force** offers a complete line of **Prepacked Screens and Accessories**. Prepacked screens allow for faster and more consistent installation than conventional monitoring well designs. **Force** prepacks are available in .75", 1.00", 1.50", and 2.00".

Please contact a **Force** representative for additional details, product availability, or assistance ordering **The Genuine Alternative!**

# SP16 GROUNDWATER SAMPLER

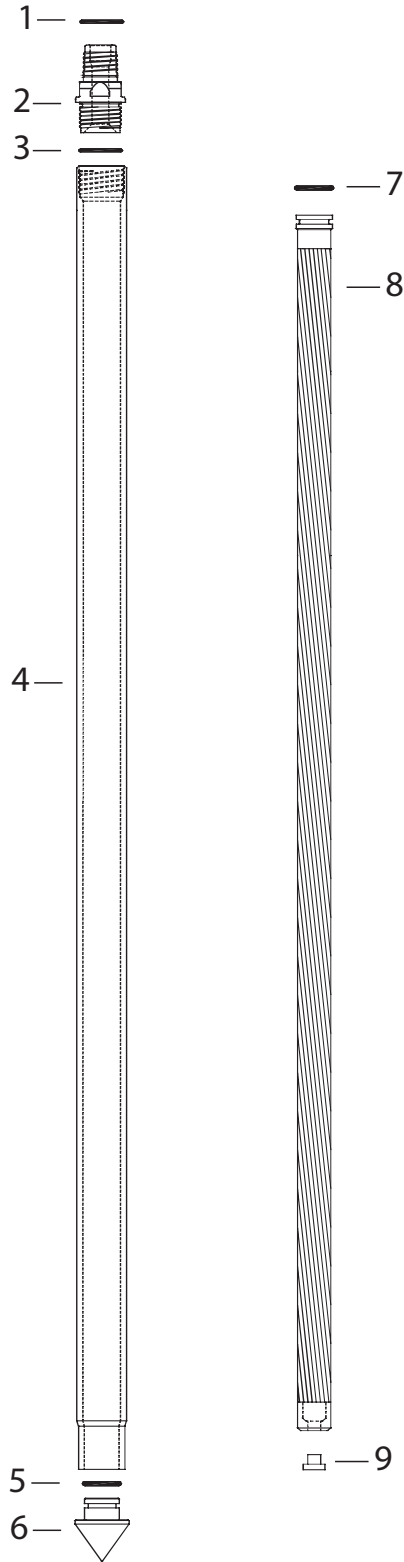

ACCESSORIES	
10	11
12	



# SP16 GROUNDWATER SAMPLER

SP16 GROUNDWATER SAMPLER				
ITEM	HP PART #	GP PART #	GP MAT #	DESCRIPTION
1	4030434	15389	202695	O-RING, SP16 PROBE ROD FOR TOP OF DRIVE HEAD
2	4030444	18307	203262	SP16 DRIVE HEAD W/ 1.50" THREAD & .500" BORE
	4030432	15188	202633	SP16 DRIVE HEAD W/ 1.50" THREAD & .625" BORE
	4030448	48110	211777	SP16 DRIVE HEAD W/ 1.25" THREAD & .500" BORE
	4030446	48109	211776	SP16 DRIVE HEAD W/ 1.25" THREAD & .625" BORE
3	4030428	13196	102256	O-RING, SP16 FOR BOTTOM OF DRIVE HEAD
4	4030430	15187	202632	SP16 SAMPLER SHEATH
5	4020110	GW1555R	214037	O-RING, ALL SP16 EXPENDABLE POINT
6	4020030	GW1555	N/A	SP16 EXPENDABLE POINT W/ 1.625" OD W/ O-RING
	4020030	GW1555K	214036	SP16 EXPENDABLE POINT W/ O-RING (25/PKG)
	4020030	GW1555L	214036	SP16 EXPENDABLE POINT W/ O-RING (120/PKG)
	4020466	GW1555AL	N/A	SP16 EXPENDABLE POINT W/ O-RING, ALUMINIUM (25/PKG)
	4030440	17066	213617	SP16 EXPENDABLE POINT W/ 1.75" OD W/ O-RING
	4030440	17066K	213617	SP16 EXPENDABLE POINT W/ 1.75" OD, W/ O-RINGS (25/PKG)
7	4020009	DT4070R	213918	O-RING, SP16 STAINLESS STEEL SCREEN HEAD
8	4020454	GW1520	214027	SP16 SCREEN, STAINLESS STEEL
	4020456	GW1530	214028	SP16 SCREEN, PVC REUSABLE
	4030442	16089	202821	SP16 SCREEN, PVC DISPOSABLE
9*	4030082	GW1552K	601033	SP16 GROUT PLUG (25/PKG)
10	4020458	GW1540	214030	SP16 GROUT PLUG PUSH ADAPTER
11	4020460	GW1535	214029	SP16 SCREEN PUSH ADAPTER
12	4020464	GW1545	214031	SP16 GROUT NOZZLE

# SP22 GROUNDWATER SAMPLER

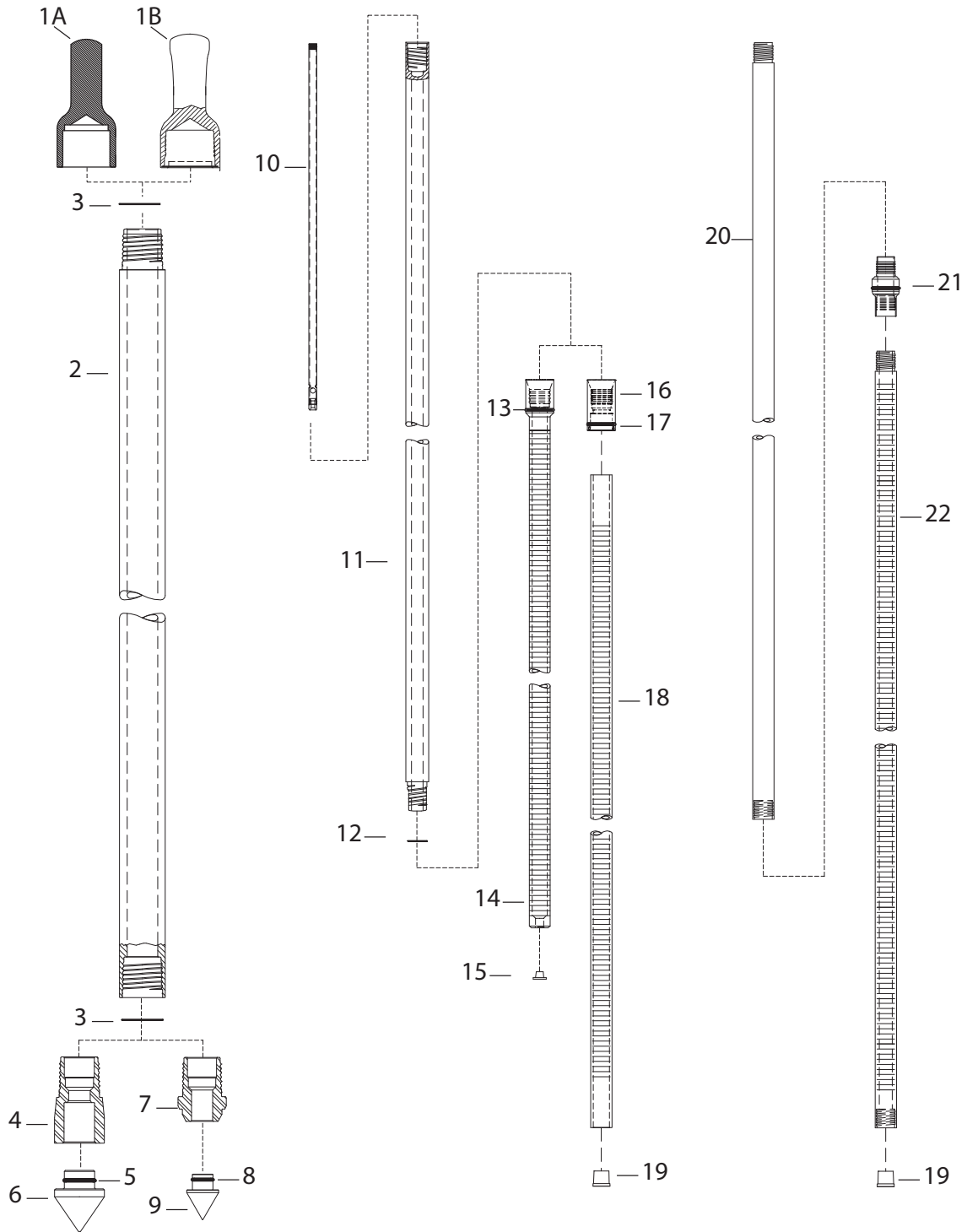

# SP22 GROUNDWATER SAMPLER

SP22 GROUNDWATER SAMPLER				
ITEM	HP PART #	GP PART #	GP MAT #	DESCRIPTION
1A	4020303	31405	206187	2.25" DRIVE CAP, THREADLESS (GH40 HAMMER)
1B	4030046	31530	206249	2.25" DRIVE CAP, THREADLESS, LONG (GH60 HAMMER)
2	4020323	25351	204777	2.25" X 12" PROBE ROD
	4030242	32656	206588	2.25" X 24" PROBE ROD
	4020324	33245	206706	2.25" X 36" PROBE ROD
	4020325	25352	204778	2.25" X 39"/1M PROBE ROD
	4030244	25300	204766	2.25" X 48" PROBE ROD
	4030245	25301	204767	2.25" X 60" PROBE ROD
3	4020312	AT2100R	213790	O-RING, 2.25" PROBE ROD (25/PKG)
4	4020488	33764	206861	2.25" EXPENDABLE POINT HOLDER
5	4020426	2799	200282	O-RING, 2.25" EXPENDABLE POINT(32/PKG)
6	4020034	AT2015	213788	2.25" EXPENDABLE POINT W/ O-RING
	4200034	AT2015K	213789	2.25" EXPENDABLE POINT W/ O-RING (32/PKG)
7	4030095	43128	209991	SP22 EXPENDABLE POINT HOLDER FOR 1.625" OD EXPENDABLE POINTS
8	4020110	GW1555R	214037	O-RING, SP15/SP16 EXPENDABLE POINT (32/PKG)
9	4020030	GW1555	214036	SP16 EXPENDABLE POINT W/ 1.625" OD W/ O-RING
	4020030	GW1555K	214036	SP16 EXPENDABLE POINT W/ O-RING (25/PKG)
	4020030	GW1555L	214036	SP16 EXPENDABLE POINT W/ O-RING (120/PKG)
	4020466	GW1555AL	N/A	SP16 EXPENDABLE POINT W/ O-RING, ALUMINIUM
	4030440	17066	216317	SP16 EXPENDABLE POINT W/ 1.75" OD W/ O-RING
	4030440	17066K	213617	SP16 EXPENDABLE POINT W/ 1.75" OD, W/ O-RINGS (25/PKG)
10	4020468	37893	208113	SP22 TUBING CHECK VALVE, STAINLESS
11	4020227	43012	209949	1.25" X 36" LIGHTWEIGHT PROBE ROD
	4020226	32318	206525	1.25" X 39"/1M LIGHTWEIGHT PROBE ROD
	4030224	21900	203988	1.25" X 48" LIGHTWEIGHT PROBE ROD
	4030277	27600	205232	1.25" X 60" LIGHTWEIGHT PROBE ROD
12	4020217	AT1250R	213771	O-RING, 1.25" PROBE ROD (25/PKG)
13	4020009	DT4070R	213918	O-RING, STAINLESS STEEL SCREEN
14	4020472	38247	208238	SP22 X 12" STAINLESS STEEL SCREEN
	4030310	37894	208114	SP22 X 48" STAINLESS STEEL SCREEN
15*	4030082	GW1552K	601033	SP22 GROUT PLUG FOR STAINLESS STEEL SCREENS (25/PKG)
16	4020482	38657	208316	SP22 SCREEN HEAD ADAPTER (STAINLESS STEEL) FOR PVC SCREENS
17	4020012	17808	N/A	O-RING, SCREEN HEAD ADAPTER
18	4020478	38667	208319	SP22 X 12" PVC SCREEN (2/BOX)
	4020480	17194	600218	SP22 X 15" PVC SCREEN (2/BOX)
	4020476	38664	208318	SP22 X 48" PVC SCREEN (2/BOX)
19*	4020462	38968	600595	SP22 PVC BOTTOM SCREEN PLUG
20	5801015	11747	201813	SP22 X 60" PVC RISER (.750")
21	4020484	37871	208102	SP22 SCREEN HEAD ADAPTER (PVC) FOR PVC SCREENS
22	4030437	17474	203101	.75" X 60" SCH 40 PVC PIPE .010" SLOT
**	4020490	37853	208095	O-RING, SERVICE KIT FOR SP22
**	4020474	37852	208094	SET SCREW SERVICE KIT FOR SP22

\*\* Service kit not shown.

# PREPACKED SCREENS

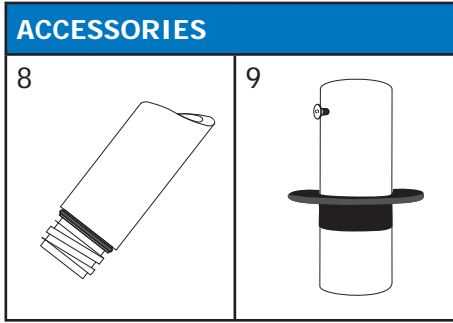
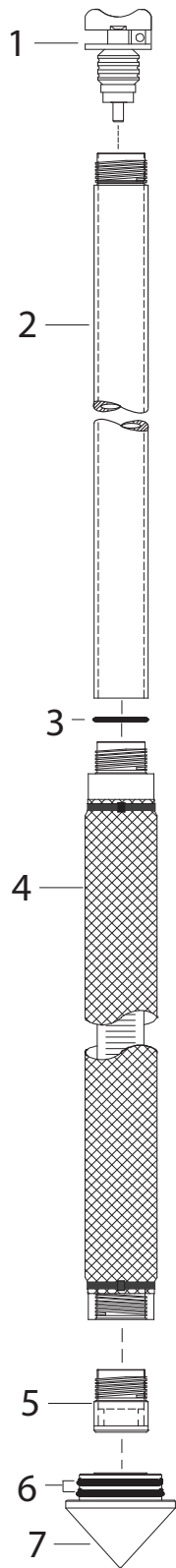

# PREPACKED SCREENS

PREPACKED SCREENS				
ITEM	HP PART #	GP PART #	GP MAT #	DESCRIPTION
1	7850007	WP1775	601078	.75" LOCKABLE EXPANSION PLUG
	7850006	WP1710	601071	1.00" LOCKABLE EXPANSION PLUG
	7850004	WP1715	601072	1.50" LOCKABLE EXPANSION PLUG
	7850000	WP1720	601073	2.00" LOCKABLE EXPANSION PLUG
2	5801015	11747	201813	.75" X 60" PVC RISER
	5800000	12876	202136	1.00" X 60" PVC RISER
	5801002	17405	203081	1.50" X 60" PVC RISER
	5800005	32320	104378	2.00" X 60" PVC RISER
3	5650190	GW4401R	214070	O-RING, FOR .75" PVC RISER (32/PKG)
	5950210	13196	102256	O-RING, FOR 1.00" PVC RISER (32/PKG)
	5650275	18782	102881	O-RING, FOR 1.50" PVC RISER (32/PKG)
	5650305	N/A	N/A	O-RING, FOR 2.00" EXPENDABLE POINT(32/PKG)
4*	4020021	17466	203095	.75" X 60" x .010" SLOT PREPACKED SCREEN (1.40" OD) - 8TPI
	4020022	17467	203096	1.00" X 60" x .010" SLOT PREPACKED SCREEN (2.50" OD) - 8TPI
	4020033	17401	203079	1.50" X 60" x .010" SLOT PREPACKED SCREEN (2.50" OD) - 8TPI
	4020029	32954	206644	2.00" X 60" x .010" SLOT PREPACKED SCREEN (3.40" OD) - 2TPI
5	5650006	12385	202059	.75" PVC BOTTOM PLUG
	5650005	12881	202137	1.00" PVC BOTTOM PLUG
	5650009	17407	203082	1.50" PVC BOTTOM PLUG
	5650080	32456	104397	2.00" PVC BOTTOM PLUG
6	4020426	2799	200282	O-RING, FOR 2.25" EXPENDABLE POINT(32/PKG)
7	4020034	AT2015	213788	2.25" EXPENDABLE DRIVE POINT (FOR .75" PREPACKS)
	4020038	AT3215	213798	3.25" EXPENDABLE DRIVE POINT (FOR 1.00" OR 1.50" PREPACKS)
	4020600	39182	208504	3.50" EXPENDABLE DRIVE POINT (FOR 1.00" OR 1.50" PREPACKS)
	4020097	N/A	219601	3.75" EXPENDABLE DRIVE POINT (FOR 2.00" PREPACKS)
	4020045	36838	207735	4.50" EXPENDABLE DRIVE POINT (FOR 2.00" PREPACKS)
8	5950025	17474	203101	.75" X 60" SCH 40 PVC PIPE .010" SLOT- 8TPI
	5950000	12875	202135	1.00" X 60" SCH 40 PVC PIPE .010" SLOT- 8TPI
	5951001	17404	203080	1.50" X 60" SCH 40 PVC PIPE .010" SLOT- 8TPI
	5950005	36200	104852	2.00" X 60" SCH 40 PVC PIPE .010" SLOT- 2TPI
9	5700150	N/A	N/A	.75" WELL DEVELOPMENT TOOL "ENVIRONMENTAL SERIES"
	5700037	35364	207276	1.00" WELL DEVELOPMENT TOOL "ENVIRONMENTAL SERIES"
	5700160	34558	207012	1.50" WELL DEVELOPMENT TOOL "ENVIRONMENTAL SERIES"
	5700038	29149	205636	2.00" WELL DEVELOPMENT TOOL "ENVIRONMENTAL SERIES"

\* Other lengths and slot sizes available.



## TOOLING & ACCESSORIES



**Force DPT** includes a comprehensive line of additional direct push tooling and field accessories to meet the needs of even the most demanding project requirements.

Included in this section are expendable points and holders, solid points, pull caps, probe rods, extension rods, rod wipers, subs and adapters, retainer wrenches, and nylon brushes. These accessories are available in all sizes to complement our complete line of tooling, soil sampling, and groundwater sampling systems.

Everything a direct push drilling operation could need and more!

Products listed in this section of the catalog are representative of the industry's most common sizes and styles. Custom tooling and additional sizes are available upon request.

Please contact a **Force** representative for additional details, product availability, or assistance ordering **The Genuine Alternative!**

# EXPENDABLE POINT HOLDERS

1.25" EXPENDABLE POINT HOLDER FOR 1.00" POINT W/ 1.10" OD		
	HP PART #	4020212
	GP PART #	PR1215
	GP MAT #	214202

1.25" EXPENDABLE POINT HOLDER FOR 1.45" OD POINT		
	HP PART #	4030466
	GP PART #	AT1213
	GP MAT #	213754

1.50" EXPENDABLE POINT HOLDER FOR 1.00" POINT W/ 1.10" OD")		
	HP PART #	4020407
	GP PART #	21444
	GP MAT #	203895

1.50" EXPENDABLE POINT HOLDER FOR 1.70" OD POINT		
	HP PART #	4020406
	GP PART #	15132
	GP MAT #	202615

1.50" EXPENDABLE POINT HOLDER POST RUN TUBING THREAD		
	HP PART #	4020408
	GP PART #	22805
	GP MAT #	204179

2.25" EXPENDABLE POINT HOLDER 2.25" OD X 48"		
	HP PART #	4020309
	GP PART #	25355
	GP MAT #	204781

2.25" EXPENDABLE POINT HOLDER 2.25" OD X 60"		
	HP PART #	4020310
	GP PART #	25356
	GP MAT #	204782

2.25" EXPENDABLE POINT HOLDER 2.25" X 2.25" OD SHORT		
	HP PART #	4020311
	GP PART #	28662
	GP MAT #	205481

2.25" EXPENDABLE POINT HOLDER 2.25" X 2.50" OD SHORT		
	HP PART #	4020139
	GP PART #	25353
	GP MAT #	204779

3.25" EXPENDABLE POINT HOLDER 3.25" OD X 39"/1M		
	HP PART #	4020501
	GP PART #	13926
	GP MAT #	202364

3.25" EXPENDABLE POINT HOLDER 3.25" OD X 48"		
	HP PART #	4020504
	GP PART #	10596
	GP MAT #	201447

3.25" EXPENDABLE POINT HOLDER 3.25" OD X 60"		
	HP PART #	4030055
	GP PART #	9796
	GP MAT #	201282

3.25" EXPENDABLE POINT HOLDER 3.25" x 3.25" OD SHORT		
	HP PART #	4030096
	GP PART #	N/A
	GP MAT #	N/A

3.25" EXPENDABLE POINT HOLDER 3.25" x 4.00" OD SHORT		
	HP PART #	4020140
	GP PART #	12270
	GP MAT #	202026

3.50" EXPENDABLE POINT HOLDER 3.50" OD x 39"/1M		
	HP PART #	4030084
	GP PART #	38955
	GP MAT #	208449

3.50" EXPENDABLE POINT HOLDER 3.50" OD X 48"		
	HP PART #	4030075
	GP PART #	38953
	GP MAT #	208447

3.50" EXPENDABLE POINT HOLDER 3.50" OD X 60"		
	HP PART #	4020240
	GP PART #	37763
	GP MAT #	208069

3.50" EXPENDABLE POINT HOLDER 3.50" X 3.50" OD SHORT		
	HP PART #	4020606
	GP PART #	N/A
	GP MAT #	N/A

3.75" EXPENDABLE POINT HOLDER 3.75" X 3.75" OD SHORT		
	HP PART #	4030451
	GP PART #	N/A
	GP MAT #	219559

4.50" EXPENDABLE POINT HOLDER 4.50" X 4.50" OD SHORT		
	HP PART #	4020710
	GP PART #	36574
	GP MAT #	207649





# EXPENDABLE POINTS

1.00" W/ 1.10" OD EXPENDABLE POINT		
	HP PART #	4020835
	GP PART #	AT14
	GP MAT #	213778

1.25" W/ 1.45" OD EXPENDABLE POINT W/ O-RING		
	HP PART #	4020208
	GP PART #	AT1214
	GP MAT #	N/A

1.25" EXPENDABLE POINT W/ O-RING (1.45" OD) SOIL GAS IMPLANT		
	HP PART #	4020219
	GP PART #	PR1214
	GP MAT #	214201

1.00" W/ 1.10" OD SOIL GAS IMPLANT ANCHOR		
	HP PART #	4030115
	GP PART #	PR14
	GP MAT #	214205

1.50" SOIL GAS IMPLANT ANCHOR EXPENDABLE POINT		
	HP PART #	4020428
	GP PART #	19570
	GP MAT #	203578

2.25" EXPENDABLE POINT 2.45" OD EXT. SHANK W/ 3 O-RINGS		
No Photo Available	HP PART #	4020314
	GP PART #	19442
	GP MAT #	203530

2.25" EXPENDABLE POINT 2.45" OD STD FOR 1 O-RING		
	HP PART #	4020034
	GP PART #	AT2015
	GP MAT #	213788

3.25" EXPENDABLE POINT W/ O-RING - ALUMINIUM		
	HP PART #	4020505
	GP PART #	N/A
	GP MAT #	N/A

3.25" EXPENDABLE POINT 5" OD W/ O-RING - LONG		
	HP PART #	4020507
	GP PART #	N/A
	GP MAT #	N/A

3.25" EXPENDABLE POINT W/ O-RING - STEEL		
	HP PART #	4020038
	GP PART #	AT3215
	GP MAT #	213798

3.50" EXPENDABLE POINT W/ O-RING		
	HP PART #	4020600
	GP PART #	39182
	GP MAT #	208504

3.75" EXPENDABLE POINT 2.45" OD EXT SHANK W/ 3 O-RINGS		
	HP PART #	4030464
	GP PART #	N/A
	GP MAT #	219601





4.50" EXPENDABLE POINT 5" OD W/ O-RING		
	HP PART #	4020045
	GP PART #	36838
	GP MAT #	207735

SP16 EXPENDABLE POINT W/ 1.75" OD (25/BOX)		
	HP PART #	4030440
	GP PART #	17066K
	GP MAT #	213617

SP16 EXPENDABLE POINT W/ 1.625" OD (25/BOX)		
	HP PART #	4020030
	GP PART #	GW1555K
	GP MAT #	214036



# SOLID POINTS

SOLID POINTS				
ITEM	HP PART #	GP PART #	GP MAT #	DESCRIPTION
	4020221	AT1245	213767	1.25" W/ 1.45" OD
	4020241	AT1244	213766	1.25" W/ 1.75" OD
	4020242	AT1247	213768	1.25" W/ 2.00" OD
	4020243	AT1242	213765	1.25" W/ 2.50" OD
	4020244	AT1252	213772	1.25" W/ 3.00" OD
	4020420	21519	203909	1.50" W/ 1.50" OD
	4020421	15219	202637	1.50" W/ 1.70" OD
	4020423	12814	202121	1.50" W/ 3.00" OD
	4020422	14512	202494	1.50" W/ 2.50" OD
	4020319	25295	204764	2.25" W/ 2.50" OD
	4020320	25357	204783	2.25" W/ 3.00" OD
	4020321	25358	204784	2.25" W/ 3.50" OD
	4020520	9729	201273	3.25" W/ 3.50" OD
	4030305	36645	207680	3.50" W/ 3.75" OD
	4030463	N/A	219277	3.75" W/ 4.00" OD
	4020815	26925	205120	4.50" W/ 5.00" OD
	4030369	35999	207515	4.50" W/ 6.00" OD





# PULL CAPS

PULL CAPS

1.25" DRIVE/PULL CAP - LONG		
No Photo Available	HP PART #	4030468
	GP PART #	N/A
	GP MAT #	N/A

1.25" PULL CAP		
	HP PART #	4030059
	GP PART #	AT1204
	GP MAT #	213751

1.25" PULL CAP W/ 1/2" NPT FEMALE THREAD		
	HP PART #	4020833
	GP PART #	17267
	GP MAT #	203036

1.25" PULL CAP, SLOTTED		
	HP PART #	4020231
	GP PART #	AT1203
	GP MAT #	213750

1.25" PULL CAP FOR GROUT INJECTION W/ 1/2" QC COUPLER		
No Photo Available	HP PART #	4020232
	GP PART #	16697
	GP MAT #	202929

1.50" PULL CAP, STANDARD NECK		
	HP PART #	4030058
	GP PART #	15090
	GP MAT #	202598

1.50" PULL CAP, SLOTTED		
	HP PART #	4020415
	GP PART #	15164
	GP MAT #	202630

1.50" PULL CAP FOR GROUT INJECTION W/ 1/2" QC COUPLER		
	HP PART #	4020416
	GP PART #	16698
	GP MAT #	202930

2.25" PULL CAP HEAVY DUTY		
	HP PART #	4020326
	GP PART #	33622
	GP MAT #	206823

3.25" PULL CAP		
	HP PART #	4030050
	GP PART #	13257
	GP MAT #	202234

3.50" PULL CAP		
	HP PART #	4030056
	GP PART #	49145
	GP MAT #	212290

3.75" PULL CAP		
	HP PART #	4030094
	GP PART #	N/A
	GP MAT #	220535

4.50" PULL CAP		
	HP PART #	4030067
	GP PART #	37343
	GP MAT #	207873

LIFTING SWIVEL PULL CAP, BOX DOWN			
HP PART #	GP PART #	GP MAT #	DESCRIPTION
4030427	43343	210092	1.25" PULL CAP
4030345	42416	209748	1.50" PULL CAP
4020327	33882	206876	2.25" PULL CAP
4020517	35358	207272	3.25" PULL CAP
4030272	37898	208115	3.50" PULL CAP
4030469	N/A	220370	3.75" PULL CAP
4020705	29502	205690	4.50" PULL CAP



FLANGE PULL RODS			
HP PART #	GP PART #	GP MAT #	DESCRIPTION
4030025	35311	207256	2.25" PULL ROD
4030431	35369	207277	3.25" PULL ROD
4030009	38183	208220	3.50" PULL ROD
4030471	N/A	220730	3.75" PULL ROD
4030061	35309	207255	4.50" PULL ROD

# PROBE RODS

**Force** probe rods are manufactured using the industry's most cutting edge techniques and from a higher grade of alloy tubing, allowing for a tougher and harder heat treating process. Our unique thread gauging process ensures full compatibility with OEM threads, and our stringent tolerances enable us to make threads that are substantially more consistent than the competition. This adds up to a more durable and longer lasting industry-standard probe rod.



PROBE ROD DIMENSIONS				
SIZE	O.D.		I.D.	
	INCHES	MM	INCHES	MM
1.25"	1.25"	31.750	.625"	15.875
1.50"	1.50"	38.100	.625"	15.875
2.25"	2.25"	57.150	1.50"	38.100
3.25"	3.25"	82.550	2.625"	66.675
3.50"	3.50"	88.900	2.75"	69.850
3.75"	3.75"	95.250	3.00"	76.200
4.50"	4.50"	114.300	3.75"	95.250







PROBE RODS			
HP PART #	GP PART #	GP MAT #	DESCRIPTION
4030279	AT1212	213753	1.25" X 12" PROBE ROD
4030222	AT1224	213758	1.25" X 24" PROBE ROD
4020229	AT1236	213762	1.25" X 36" PROBE ROD
4020230	AT1239	213763	1.25" X 39"/1M PROBE ROD
4030270	AT1248	213769	1.25" X 48" PROBE ROD
4030267	AT1260	213773	1.25" X 60" PROBE ROD
4030232	15471	202714	1.50" X 12" PROBE ROD
4020412	15472	202715	1.50" X 24" PROBE ROD
4020413	35325	207261	1.50" X 36" PROBE ROD
4020411	17899	203193	1.50" X 39"/1M PROBE ROD
4020414	13359	202248	1.50" X 48" PROBE ROD
4030235	11121	201682	1.50" X 60" PROBE ROD
4020323	25351	204777	2.25" X 12" PROBE ROD
4030242	32656	206588	2.25" X 24" PROBE ROD
4020324	33245	206706	2.25" X 36" PROBE ROD
4020325	25352	204778	2.25" X 39"/1M PROBE ROD
4030244	25300	204766	2.25" X 48" PROBE ROD
4030245	25301	204767	2.25" X 60" PROBE ROD
4020508	13672	202313	3.25" X 12" PROBE ROD
4030252	18405	203284	3.25" X 24" PROBE ROD
4020509	N/A	N/A	3.25" X 36" PROBE ROD
4020510	13925	202363	3.25" X 39"/1M PROBE ROD
4020511	10594	201446	3.25" X 48" PROBE ROD
4030250	9040	201185	3.25" X 60" PROBE ROD

PROBE RODS			
HP PART #	GP PART #	GP MAT #	DESCRIPTION
4020601	51765	213362	3.50" X 12" PROBE ROD
4030266	38173	208219	3.50" X 24" PROBE ROD
4020602	N/A	N/A	3.50" X 36" PROBE ROD
4020603	38952	214781	3.50" X 39"/1M PROBE ROD
4030264	38951	208446	3.50" X 48" PROBE ROD
4030265	36641	215664	3.50" X 60" PROBE ROD
4030457	N/A	220395	3.75" X 12" PROBE ROD
4030456	N/A	219278	3.75" X 24" PROBE ROD
4030459	N/A	N/A	3.75" X 39"/1M PROBE ROD
4030458	N/A	220539	3.75" X 48" PROBE ROD
4030462	N/A	219275	3.75" X 60" PROBE ROD
4020709	39302	208532	4.50" X 12" PROBE ROD
4020706	31865	206412	4.50" X 24" PROBE ROD
4020702	34008	206890	4.50" X 39"/1M PROBE ROD
4020700	25404	204797	4.50" X 48" PROBE ROD
4020704	28887	205555	4.50" X 60" PROBE ROD

## LIGHTWEIGHT PROBE RODS

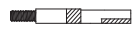
LIGHTWEIGHT PROBE RODS			
HP PART #	GP PART #	GP MAT #	DESCRIPTION
4020227	43012	209949	1.25" X 36" LIGHTWEIGHT PROBE ROD
4020226	32318	206525	1.25" X 39"/1M LIGHTWEIGHT PROBE ROD
4030224	21900	203988	1.25" X 48" LIGHTWEIGHT PROBE ROD
4030277	27600	205232	1.25" X 60" LIGHTWEIGHT PROBE ROD

## EXTENSION RODS & ACCESSORIES

EXTENSION RODS & ACCESSORIES				
HP PART #	GP PART #	GP MAT #	DESCRIPTION	
4020169	AT67	213832	36" EXTENSION ROD SS	
4020168	AT675	213835	39"/1M EXTENSION ROD SS	
4020167	AT671	213833	48" EXTENSION ROD SS	
4020166	10073	201352	60" EXTENSION ROD SS	
4020160	AT69	213837	EXTENSION ROD HANDLE	
4030426	AT6712	213834	EXTENSION ROD CENTERING PLUG FOR STOP PIN	
4030452	9754	201276	QUICK LINK STOP PIN REMOVER	
4030476	AT68	213836	EXTENSION ROD COUPLER	
4020170*	AT695	213838	EXTENSION ROD QUICK LINK PIN	
4020171*	AT696	213839	EXTENSION ROD QUICK LINK BOX	

## ROD WIPERS

ROD WIPERS			
HP PART #	GP PART #	GP MAT #	DESCRIPTION
4020211	23852	600341	1.25"/1.50" PROBE ROD WIPER
4020331	26876	600412	2.25" PROBE ROD WIPER
4020518	27194	600418	3.25" PROBE ROD WIPER
4020518	27194	600418	3.50" PROBE ROD WIPER
4030474	N/A	220390	3.75" PROBE ROD WIPER
4030475	22976	600448	4.50" PROBE ROD WIPER

## NYLON BRUSHES

NYLON BRUSHES			
HP PART #	GP PART #	GP MAT #	DESCRIPTION
4030477	BU1250	600996	1.25"/1.50" NYLON BRUSH
4020302	BU2125	600998	2.25" NYLON BRUSH
4020516	BU3250	601000	3.25" NYLON BRUSH
4020832	BU700	601003	MC5 NYLON BRUSH
4030478	BU300	600999	GROUNDWATER TOOL BRUSH

## SUBS & ADAPTERS

SUBS & ADAPTERS*			
HP PART #	GP PART #	GP MAT #	DESCRIPTION
4020350	AT1228	213761	ADAPTER, 1.25" PIN X AW PIN
4020200	15812	202789	ADAPTER, 1.25" BOX TO 1.50" PIN
4020352	32696	206603	ADAPTER, 1.50" PIN X AW BOX
4020351	17320	203052	ADAPTER, 1.50" PIN X AW PIN
4020353	17885	203192	ADAPTER, 1.50" PIN X AWJ PIN
4020354	17884	203191	ADAPTER, 1.50" BOX X AWJ PIN
4020201	15813	202790	ADAPTER, 1.50" BOX TO 1.25" PIN
4020355	35972	207506	ADAPTER, 2.25" PIN X AWJ PIN
4020356	45769	210906	ADAPTER, 2.25" BOX X AWJ PIN
4020300	25359	204785	ADAPTER, 2.25" BOX TO 1.50" PIN
4020301	25360	204786	ROD TO CAP ADAPTER, 2.25" PIN TO HSA

\*Additional sizes and styles available on request.

## RETAINER WRENCHES

RETAINER WRENCHES			
HP PART #	GP PART #	GP MAT #	DESCRIPTION
4030344	27838	205299	DT325/DT35 RETAINER WRENCH
4020909	30302	205773	MC7 CUTTING SHOE WRENCH / DT45 RETAINER WRENCH

# PART NUMBER REFERENCE GUIDE:

## Geoprobe® Part # to Hole Products Part #

GEOPROBE® PART #	HOLE PRODUCTS PART #	DESCRIPTION	PAGE #
2799	4020426	O-RING, 2.25" EXP. POINT (32/PKG)	7, 39, 41
5131	4020816	MC5 LINER CLEAR TEFLON 48"	20
5867	4020214	1.00"/1.25" ROD GRIP JAW (GH40)	3
6370	4020316	3.25" ROD GRIP SCREW	9
6370	4020316	3.50" ROD GRIP SCREW	11
6370	4020316	3.75" ROD GRIP SCREW	13
6370	4020316	4.50" ROD GRIP SCREW	15
7332	4020822	MC5 LINER SS LONG SECTION	20
7333	4020823	MC5 LINER SS SHORT SECTION	20
7702	4020708	"O-RING, 4.50"" EXP. POINT	15
8398	4020204	1.25" DRIVE CAP, THREADLESS (GH60)	3
9016	4020839	MC5 STOP PIN COUPLER	20
9038	4030274	MC5 PISTON ROD 48"	20
9040	4030250	3.25" X 60" PROBE ROD	9, 27, 48
9096	4020527	3.25" ROD GRIP BODY (GH60)	9
9729	4020520	3.25" SOLID DRIVE POINT (3.50" OD)	9
9742	4030049	3.25" DRIVE CAP, THREADLESS (GH60)	9, 27
9751	4030402	O-RING, DT45 SOLID DRIVE POINT	33
9754	4030452	MC/MC5 QUICK LINK STOP PIN REMOVER	20, 50
9757	4020526	3.25" ROD GRIP HANDLE ASSEMBLY (GH60)	9
9774	4020470	3.25" ROD GRIP V-BLOCK RETAINING PIN	9
9774	4020470	3.50" ROD GRIP V-BLOCK RETAINING PIN	11
9796	4030055	3.25" EXP. POINT HOLDER 60" LONG	9
9960	4020514	O-RING, 3.25" PROBE ROD (25/PKG)	9
9960	4020514	O-RING, DT325/DT35 CUTTING SHOE	27, 29
10069	4020840	MC/MC5 STOP PIN FOR 1.25" & 2.25" DRIVE HEADS	20
10073	4020166	60" EXTENSION ROD SS	50
10074	4020005	MC5 LINER CLEAR PVC 60" (66/BOX)	19
10212	4030338	DT325/DT35/DT37 DRIVE HEAD FOR SAMPLER SHEATH W/ 1.25" THREAD	27, 29, 31
10594	4020511	3.25" X 48" PROBE ROD	9, 27, 48
10596	4020504	3.25" EXP. POINT HOLDER 48" LONG	9
10605	4020500	3.25" DRIVE CAP, THREADLESS (GH40)	9
10727	4030281	MC5 PISTON ROD 60"	20
10728	4020826	MC5 PISTON ROD 36"	20
10729	4020825	MC5 PISTON ROD 24"	20
10732	4020824	MC5 PISTON ROD 39"/1M	20
11121	4030235	1.50" X 60" PROBE ROD	5, 48
11747	5801015	SP22 X 60" PVC RISER (.750")	39
11747	5801015	.75" X 60" PVC RISER	41
12126	4030470	"3.25"" ROD GRIP JAW PAD (GH60)	9
12126	4030470	3.50" ROD GRIP JAW PAD (GH60)	11
12126	4030470	3.75" ROD GRIP JAW PAD (GH60)	13
12126	4030470	4.50" ROD GRIP JAW PAD (GH60)	15
12228	4020525	3.25" ROD GRIP JAW (GH40)	9
12235	4020523	3.25" ROD GRIP HANDLE ASSEMBLY (GH40)	9
12270	4020140	3.25" EXP. POINT HOLDER SHORT (4.00" OD)	9
12385	5650006	.75" PVC BOTTOM PLUG	41
12787	4030041	1.50" DRIVE CAP, THREADLESS (GH60)	5
12814	4020423	1.50" SOLID DRIVE POINT THREADED (3.00" OD)	5
12875	5950000	1.00" X 60" PVC PIPE .010" SLOT	41
12876	5800000	1.00" X 60" PVC RISER	41
12881	5650005	1.00" PVC BOTTOM PLUG	41
12943	4030268	DT325 CENTERING DRIVE CAP	27
13162	4020121	DT22 BOLT FOR LINER DRIVE HEAD (20/PKG)	25
13196	4030428	O-RING, SP16 FOR BOTTOM OF DRIVE HEAD	37
13257	4030050	3.25" PULL CAP	9, 27
13359	4020414	1.50" X 48" PROBE ROD	5, 48

GEOPROBE® PART #	HOLE PRODUCTS PART #	DESCRIPTION	PAGE #
13672	4020508	3.25" X 12" PROBE ROD	9, 29, 48
13896	4020315	2.25" EXP. POINT IMPLANT ANCHOR (2.45" OD)	7
13925	4020510	3.25" X 39"/1M PROBE ROD	9, 27, 48
13926	4020501	3.25" EXP. POINT HOLDER 1M LONG	9
13942	4030356	"O-RING, FOR DT325/DT35 DISCRETE POINT (25/PKG)	27
13942	4030356	"O-RING, FOR DT325/DT35 DISCRETE POINT (25/PKG)	29
14506	4020330	2.25" CENTERING TOOL FOR EXTENSION RODS	7
14512	4020422	1.50" SOLID DRIVE POINT THREADED (2.50" OD)	5
15090	4030058	1.50" PULL CAP STANDARD NECK	5
15132	4020406	1.50" EXP. POINT HOLDER FOR 1.70" OD POINT	5
15164	4020415	1.50" PULL CAP W/ SLOT	5
15187	4030430	SP16 SAMPLER SHEATH	37
15188	4030432	SP16 DRIVE HEAD W/ 1.50" THREAD & .625" BORE	37
15219	4020421	1.50" SOLID DRIVE POINT THREADED (1.70" OD)	5
15275	4020216	1.25"/1.50" ROD GRIP JAW (GH60)	3, 5
15389	4030429	O-RING FOR 1.50" PROBE ROD (25/PKG)	5
15389	4030434	O-RING, SP16 PROBE ROD FOR TOP OF DRIVE HEAD	37
15471	4030232	1.50" X 12" PROBE ROD	5, 48
15472	4020412	1.50" X 24" PROBE ROD	5, 48
15527	4030105	MC/MC5 STOP PIN FOR 1.50" DRIVE HEAD	20
15554	4020220	1.25"/1.50" ROD GRIP HANDLE ASSEMBLY (GH60)	3, 5
15582	4030069	1.50" ROD GRIP JAW (GH40)	5
15590	4020403	1.50" DRIVE CAP, W/ THREADS (GH40)	5
15607	4020402	1.50" DRIVE CAP, SLOTTED, W/ THREADS (GH40)	5
15812	4020200	ADAPTER, 1.25" BOX TO 1.50" PIN	3, 5, 50
15813	4020201	ADAPTER, 1.50" BOX TO 1.25" PIN	3, 5, 50
16089	4030442	SP16 SCREEN, PVC DISPOSABLE	37
16315	4020821	MC5 LINER SS 60"	20
16490	4020519	"O-RING, 3.25"" EXP. POINT (EACH)	9
16697	4020232	1.25" GROUT INJECTION PULL CAP	3
16698	4020416	1.50" GROUT INJECTION PULL CAP	5
16792	4020308	"3.25""/3.50"" ROD GRIP HAMMER V-BLOCK (GH60)	9, 11
17066	4030440	SP16 EXP. POINT W/ 1.75" OD W/ O-RING	37, 39
17194	4020480	SP22 X 15" PVC SCREEN (2/BOX)	39
17267	4020833	1.25" PULL CAP W/ 1/2" NPT FEMALE THREAD	3
17401	4020033	1.50" X 60" X .010" SLOT PREPACKED SCREEN (2.50" OD) - 8TPI	41
17404	5951001	1.50" X 60" PVC PIPE .010" SLOT	41
17405	5801002	1.50" X 60" PVC RISER	41
17407	5650009	1.50" PVC BOTTOM PLUG	41
17466	4020021	.75" X 60" X .010" SLOT PREPACKED SCREEN (1.40" OD) - 8TPI	41
17467	4020022	1.00" X 60" X .010" SLOT PREPACKED SCREEN (2.50" OD) - 8TPI	41
17474	4030437	.75" X 60" SCH 40 PVC PIPE .010" SLOT	39, 41
17762	4020112	DT325/DT35/DT37 VINYL LINER CAPS	27, 29, 31
17808	4020012	O-RING, SCREEN HEAD ADAPTER	39
17899	4020411	1.50" X 39"/1M PROBE ROD	5, 48
18017	4030455	O-RING, 1.25 & 1.50 GROUT INJECTION PULL CAP	5, 7
18307	4030444	SP16 DRIVE HEAD W/ 1.50" THREAD & .500" BORE	37
18405	4030252	3.25" X 24" PROBE ROD	9, 48
19442	4020314	2.25" EXP. POINT EXT. SHANK (2.45" OD) W/ 3 O-RINGS	7
19520	4020831	MC5 PLUNGER FOR HYDRAULIC LINER	20
19743	4030044	O-RING, MC7 PISTON POINT	23
20737	4020522	3.25" SPT CUTTING SHOE W/ 2.38" ID X 3.750" OD FOR SPLIT SPOON	9
21075	4020401	1.50" DRIVE CAP, SLOTTED, THREADLESS(GH40)	5
21114	4020521	3.25" SPT SOLID DRIVE POINT W/ 1.50" MALE THREAD FOR SPLIT SPOON	9
21444	4020407	1.50" EXP. POINT HOLDER FOR 1.10" OD POINT	5

# PART NUMBER REFERENCE GUIDE:

## Geoprobe® Part # to Hole Products Part #

GEOPROBE® PART #	HOLE PRODUCTS PART #	DESCRIPTION	PAGE #
21519	4020420	1.50" SOLID DRIVE POINT THREADED (1.50" OD)	5
21900	4030224	1.25" X 48" LIGHTWEIGHT PROBE ROD	3, 19, 25, 27, 29, 39, 49
22922	4030060	MC5 CUTTING SHOE 1.50" ID W/ STANDARD SHANK (2.30" OD)	19
22923	4030035	MC5 SAMPLER TUBE 48"	19
22955	4030043	DT22 DRIVE CAP 1.25" THREADLESS	25
22956	4030278	DT22 DISCRETE POINT FOR USE W/ 1.25" INNER RODS	25
22976	4030475	4.50" PROBE ROD WIPER	50
22990	4030042	MC5 DRIVE HEAD X 1.50" FOR STOP PIN	19
22992	4030030	MC5 SAMPLER TUBE 60"	19
23418	4020203	1.25"/1.50" ROD GRIP BODY (GH60)	3, 5
23639	4030088	MC5 DRIVE CAP FOR CENTER RODS	19, 23
23641	4020800	MC5 CENTER ROD PLUG 1.25" MALE THREAD	19
23663	4020202	1.25"/1.50" ROD GRIP BODY (GH40)	3, 5
23664	4020336	2.25" ROD GRIP BODY (GH40)	7
23665	4020524	3.25" ROD GRIP BODY (GH40)	9
23666	4020333	2.25" ROD GRIP BODY (GH60)	7
23852	4020211	1.25"/1.50" ROD WIPER	3, 5, 50
23978	4030070	MC5 CUTTING SHOE 1.50" ID W/ EXT. SHANK (2.375" OD)	19
24237	4020841	MC5 SAMPLER TUBE 24"	19
24238	4020829	MC5 SAMPLER TUBE 36"	19
24239	4020830	MC5 SAMPLER TUBE 39"/1M	19
25295	4020319	2.25" SOLID DRIVE POINT (2.50" OD)	7
25300	4030244	2.25" x 48" PROBE ROD	7, 13, 25, 33, 39, 48
25301	4030245	2.25" x 60" PROBE ROD	7, 13, 25, 33, 39, 48
25341	4030072	DT22 SHOE STANDARD SIZE 2.375" OD X 1.125" ID	25
25351	4020323	2.25" x 12" PROBE ROD	7, 13, 25, 33, 39, 48
25352	4020325	2.25" x 39"/1M PROBE ROD	7, 13, 25, 33, 39, 48
25353	4020139	2.25" EXP. POINT HOLDER SHORT (2.50" OD)	7
25355	4020309	2.25" EXP. POINT HOLDER 48" LONG (2.25" OD)	7
25356	4020310	2.25" EXP. POINT HOLDER 60" LONG 2.25" OD)	7
25357	4020320	2.25" SOLID DRIVE POINT (3.00" OD)	7
25358	4020321	2.25" SOLID DRIVE POINT (3.50" OD)	7
25359	4020300	ADAPTER, 2.25" BOX TO 1.50" PIN	7, 50
25360	4020301	ROD TO CAP ADAPTER, 2.25" PIN TO HSA	7, 50
25362	4020304	2.25" DRIVE CAP, W/ THREADS (GH40)	7, 25
25404	4020700	4.50" X 48" PROBE ROD	15, 33, 48
26078	4030062	MC5 CUTTING SHOE 1.25" ID W/ EXT. SHANK (2.375" OD)	19
26183	4030040	MC5 DRIVE HEAD X 1.25" FOR STOP PIN	19
26622	4020703	4.50" DRIVE CAP, BOX DOWN, THREADLESS (GH60/80)	15, 33
26718	4030342	DT325/DT35/DT37 LINER RETAINER W/ GROOVE	27, 29, 31
26719	4030362	DT325/DT35/DT37 SAMPLER SHEATH 60"	27, 29, 31
26720	4030322	DT325 CUTTING SHOE 1.75" ID X 3.450" OD	27
26805	4030364	DT325/DT35/DT37 SAMPLER SHEATH 72"	27, 29, 31
26865	4030080	MC5 POINT CLOSED PISTON UNDER SIZED 1.35" OD W/ O-RINGS	19
26876	4020331	2.25" ROD WIPER	7, 50
26925	4020815	4.50" SOLID POINT, THREADED (5.00" OD)	15
27194	4020518	3.25" ROD WIPER	9, 50
27194	4020518	3.50" ROD WIPER	11, 50
27216	4020103	ADJUSTABLE CENTER ROD CLAMP FOR 1.25" RODS	25
27600	4030277	1.25" X 60" LIGHTWEIGHT PROBE ROD	3
27600	4030277	1.25" X 60" LIGHTWEIGHT PROBE ROD	19, 25, 27, 29, 39, 49
27711	4030360	DT325/DT35/DT37 SAMPLER SHEATH 48"	27, 29, 31

GEOPROBE® PART #	HOLE PRODUCTS PART #	DESCRIPTION	PAGE #
27712	4030358	DT325/DT35/DT37 SAMPLER SHEATH 39"/1M	27, 29, 31
27763	4030336	DT325/DT35 DISCRETE POINT 1.75" OD W/ 1.25" PIN UP	27, 29
27813	4020100	DT325/DT35/DT37 LINER 60" W/ CORE CATCHER (42/BOX)	27, 29, 31
27814	4020108	DT325/DT35/DT37 LINER 48" W/ CORE CATCHER (42/BOX)	27, 29, 31
27815	4030348	DT325/DT35/DT37 LINER 39"/1M W/ CORE CATCHER (42/BOX)	27, 29, 31
27838	4030344	DT325/DT35 RETAINER WRENCH	27, 29, 31
27999	4030280	MC5 DRIVE HEAD X 1.50" W/ 1/4" BORE NO STOP PIN	19
28001	4020806	MC5 DRIVE HEAD X 1.25" W/ 1/8" BORE NO STOP PIN	19
28113	4030079	MC5 POINT CLOSED PISTON STANDARD SIZE 1.50" OD W/ O-RING	19
28339	4030320	DT325 HOLDER FOR EXP. CUTTING SHOE	27
28341	4030366	DT325/DT35/DT37 EXP. CUTTING SHOE (1.75" ID)	27, 29, 31
28379	4030352	O-RING, DT325, DT35, DT37 LINER RETAINER (25/PKG)	27, 29, 31
28508	4030077	DT325 CUTTING SHOE 1.85" ID	27
28509	4030271	DT325/DT35 DISCRETE POINT 1.85" OD W/ 1.25" PIN UP	27, 29
28646	4020812	MC5 DRIVE HEAD X 2.25" W/ 1.375" BORE	19
28647	4030045	MC5 DRIVE HEAD X 2.25" FOR STOP PIN	19
28662	4020311	2.25" EXP. POINT HOLDER SHORT( 2.25" OD)	7
28887	4020704	4.50" X 60" PROBE ROD	15, 33, 48
28930	4020334	2.25" ROD GRIP JAW (GH60)	7
29149	5700038	2.00" WELL DEVELOPMENT TOOL "ENV. SERIES"	41
29358	4030368	DT325/DT35/DT37 LINER SPACER CONNECTOR	27, 29, 31
29385	4020332	2.25" ROD GRIP HANDLE ASSEMBLY (GH60)	7
29457	4020337	2.25" ROD GRIP JAW (GH40)	7
29461	4020335	2.25" ROD GRIP HANDLE ASSEMBLY (GH40)	7
29502	4020705	4.50" LIFTING SWIVEL PULL CAP, BOX DOWN	15
29532	4020828	MC5 ADAPTER FOR HYDRAULIC EXTRUDER	20
29552	4020060	MC5 CUTTING SHOE 1.35" ID W/ STANDARD EXT. SHANK (2.375" OD)	19
29609	4030346	DT325/DT35/DT37 LINER SPACER 11.50" REFILL	27, 29, 31
29919	4020837	MC5 CUTTING SHOE (2.25" OD) EXT SHANK	20
29976	4030475	4.50" ROD WIPER	15
30004	4030370	4.50" CASING SHOE (3.55" ID, 5.00" OD)	15
30248	4030410	DT45 SAMPLE TUBE 48"	33
30250	4030412	DT45 SAMPLE TUBE 60"	33
30252	4030414	DT45 SAMPLE TUBE 72"	33
30289	4030384	DT45 DRIVE HEAD FOR 1.25" CENTER RODS	33
30302	4020909	MC7 CUTTING SHOE WRENCH / DT45 RETAINER WRENCH	23, 33, 50
30436	4030392	DT45 LINER SPACER CONNECTOR	33
30450	4030416	DT45 CUTTING SHOE	33
31405	4020303	2.25" DRIVE CAP, THREADLESS (GH40)	7, 19, 25, 39
31499	4020234	1.25" LEAF PULLER ASSEMBLY	3
31530	4030046	2.25" DRIVE CAP, THREADLESS, LONG (GH60)	7, 19, 23, 25, 39
31690	4020506	4.50" ROD GRIP HAMMER V-BLOCK (GH60)	15
31865	4020706	4.50" X 24" PROBE ROD	15, 33, 48
31909	4020707	4.50" ROD GRIP HANDLE ASSEMBLY (GH60)	15
32035	4030068	MC5 CUTTING SHOE 1.35" ID W/ EXT. SHANK (2.30" OD)	19
32279	4020701	4.50" ROD GRIP BODY (GH60)	15
32318	4020226	1.25" X 39"/1M LIGHTWEIGHT PROBE ROD	3, 19, 25, 27, 29, 39, 49
32320	5800005	2.00" X 60" PVC RISER	41
32335	4030386	DT45 DRIVE HEAD FOR 2.25" CENTER RODS	33
32349	4030406	DT45 LINER RETAINER	33
32381	4030420	DT45 CENTERING DRIVE CAP 2.25" ROD	33
32456	5650080	2.00" PVC BOTTOM PLUG	41
32490	4030071	MC5 CUTTING SHOE W/ MC5 THREAD, STANDARD SHANK (2.25" OD)	19
32526	4030396	DT45 LINER SPACER 12"	33



# PART NUMBER REFERENCE GUIDE:

## Geoprobe® Part # to Hole Products Part #

GEOPROBE® PART #	HOLE PRODUCTS PART #	DESCRIPTION	PAGE #
32656	4030242	2.25" x 24" PROBE ROD	7, 25, 33, 39, 48
32663	4020838	4.50" SOLID DRIVE / DISCRETE POINT	15
32665	4020836	O-RING, 4.50" SOLID DRIVE / DISCRETE POINT (10/PKG)	15
32693	4030380	DT45 DRIVE CAP BUFFERING 1.25" RODS	33
32694	4030382	DT45 DRIVE CAP BUFFERING 2.25" ROD	33
32940	4030388	DT45 EXP. CUTTING SHOE HOLDER 4.50" OD (3.75 ID)	33
32952	4020329	2.25" LEAF PULLER ASSEMBLY	7
32954	4020029	2.00" X 60" X .010" SLOT PREPACKED SCREEN (3.40" OD) - 2TPI	41
33245	4020324	2.25" x 36" PROBE ROD	7, 25, 33, 39, 48
33622	4020326	2.25" PULL CAP HD	7, 25
33764	4020488	"2.25"" EXP. POINT HOLDER	39
33882	4020327	2.25" LIFTING SWIVEL PULL CAP, BOX DOWN	7
34008	4020702	4.50" X 39"/1M PROBE ROD	15, 33, 48
34081	4030408	DT45 SAMPLE TUBE 39"/1M	33
34086	4030404	DT45 SOLID DRIVE / DISCRETE POINT (2.25" BOX UP)	33
34454	4020906*	MC7/DT45 CORE CATCHER	23, 33
34558	5700160	1.50" WELL DEVELOPMENT TOOL"ENV. SERIES"	41
34887	4030418	DT45 EXP. CUTTING SHOE	33
34888	4030400	O-RING, DT45 EXP. CUTTING SHOE	33
34900	4030398	"O-RING, 4.50"" PROBE ROD (25/PKG)	15, 33
35234	4030315	4.50" CASING SHOE (3.55" ID, 6.00" OD)	15
35309	4030061	4.50" FLANGE PULL ROD	15
35311	4030025	2.25" FLANGE PULL ROD	7
35325	4020413	1.50" X 36" PROBE ROD	5, 48
35358	4020517	3.25" LIFTING SWIVEL PULL CAP, BOX DOWN	9
35364	5700037	1.00" WELL DEVELOPMENT TOOL "ENV. SERIES"	41
35369	4030431	3.25" FLANGE PULL ROD	9
35392	4020206	1.25" DRIVE CAP, LONG, THREADLESS (GH40)	3
35621	4020328	2.25" LIFTING SWIVEL PULL CAP, PIN DOWN	7
35806	4020113	MC7/DT45 VINYL LINER CAPS	23, 33
35999	4030369	4.50" SOLID POINT, THREADED (6.00" OD)	15
36200	5950005	2.00" X 60" PVC PIPE .010" SLOT	41
36574	4020710	4.50" EXP. POINT HOLDER SHORT (4.50" OD)	15
36641	4030265	3.50" X 60" PROBE ROD	11, 29, 48
36642	4030057	3.50" DRIVE CAP, THREADLESS (GH60/80)	11, 29
36645	4030305	3.50" SOLID DRIVE POINT	11
36815	4030332	DT35 HOLDER FOR EXP. CUTTING SHOES	29
36838	4020045	4.50" EXP. POINT W/ O-RING (5.00" OD)	15
36838	4020045	4.50" EXP. DRIVE POINT (FOR 2.00" PREPACKS)	41
37275	4030421	2.25" GROUT INJECTION PULL CAP	7
37303	4020452	O-RING, 2.25" GROUT INJECTION PULL CAP	3, 5, 7
37343	4030067	4.50" HD PULL CAP	15
37708	4030318	DT325 BUFFERING DRIVE CAP	27
37758	4030076	DT35 CUTTING SHOE STANDARD 1.85" ID X 3.75" OD	29
37763	4020240	3.50" EXP. POINT HOLDER 60" LONG	11
37852	4020474	SET SCREW SERVICE KIT FOR SP22	39
37853	4020490	O-RING, SERVICE KIT FOR SP22	39
37871	4020484	SP22 SCREEN HEAD ADAPTER (PVC) FOR PVC SCREENS	39
37893	4020468	SP22 CHECK VALVE TUBING, STAINLESS	39
37894	4030310	SP22 X 48" STAINLESS STEEL SCREEN	39
37898	4030272	3.50" LIFTING SWIVEL PULL CAP, BOX DOWN	11
38173	4030266	3.50" X 24" PROBE ROD	11, 29, 48
38183	4030009	3.50" FLANGE PULL ROD	11
38247	4020472	SP22 X 12" STAINLESS STEEL SCREEN	39
38381	4030330	DT35/DT37 CENTERING DRIVE CAP	29, 31
38657	4020482	SP22 SCREEN HEAD ADAPTER (SS) FOR PVC SCREENS	39

GEOPROBE® PART #	HOLE PRODUCTS PART #	DESCRIPTION	PAGE #
38664	4020476	SP22 X 48" PVC SCREEN (2/BOX)	39
38667	4020478	SP22 X 12" PVC SCREEN (2/BOX)	39
38752	4020004	MC5 LINER CLEAR TEFLON 60"	20
38951	4030264	3.50" X 48" PROBE ROD	11, 29, 48
38952	4020603	3.50" X 39"/1M PROBE ROD	11, 29, 48
38953	4030075	3.50" EXP. POINT HOLDER 48" LONG	11
38955	4030084	3.50" EXP. POINT HOLDER 1M LONG	11
38968	4020462*	SP22 PVC BOTTOM SCREEN PLUG	39
38982	4030605	3.50" DRIVE CAP, THREADLESS (GH40)	11
38983	4020803	3.50" ROD GRIP HANDLE ASSEMBLY (GH40)	11
39011	4030269	DT325/DT35/DT37 LINER RETAINER, HEAVY DUTY	27, 29, 31
39178	4030334	DT35 CUTTING SHOE 1.85" ID X 3.50" OD	29
39182	4020600	3.50" EXP. POINT W/ O-RING	11, 41
39247	4020136	4.50" EXP. POINT W/ O-RING (4.50" OD)	15
39302	4020709	4.50" X 12" PROBE ROD	15, 33, 48
40167	4020417	1.50" LEAF PULLER ASSEMBLY	5
41675	4030350	DT22 THREAD CUTTING DRIVE HEAD (FISHING TOOL)	25
42416	4030345	1.50" LIFTING SWIVEL PULL CAP	5
43012	4020227	1.25" X 36" LIGHTWEIGHT PROBE ROD	3, 19, 25, 39, 49
43128	4030095	DT22/SP22 EXP. POINT HOLDER FOR 1.625" OD EXP. POINTS	25, 39
43239	4030326	DT35/DT37 BUFFERING DRIVE CAP	29, 31
43240	4030328	DT35/DT37 BUFFERING DRIVE CAP, HEAVY DUTY	29, 31
43343	4030427	1.25" LIFTING SWIVEL PULL CAP	3
44688	4020804	3.50" ROD GRIP HANDLE ASSEMBLY (GH60)	11
44689	4020810	3.50" ROD GRIP BODY (GH60)	11
45603	4020905	MC7 CORE CATCHER SPACER RING	23
46065	4020105	DT45 LINER CLEAR PVC 60" (18/BOX)	23, 33
46066	4030390	DT45 LINER CLEAR PVC 72" (18/BOX)	23, 33
46125	4020107	DT45 LINER CLEAR PVC 48" (18/BOX)	23, 33
48109	4030446	SP16 DRIVE HEAD W/ 1.25" THREAD & .625" BORE	37
48110	4030448	SP16 DRIVE HEAD W/ 1.25" THREAD & .500" BORE	37
48181	4030026	2.25" DRIVE CAP, SLOTTED, THREADLESS (GH60)	7
48302	4020903	MC7 SAMPLE SHEATH 60"	23
48423	4020900	MC7 DRIVE HEAD W/ 2.25" PIN	23
48762	4020605	4.50" DRIVE CAP, PIN DOWN, THREADLESS (GH60/80)	15
49145	4030056	3.50" HD/DT35 PULL CAP	11, 29
49852	4020802	DRIVE CUSHION ASSEMBLY	25
50271	4030093	DT22 HOLDER FOR EXP. SHOES	25
50726	4020307	DT22 EXP. CUTTING SHOE (2.375" OD) W/ O-RINGS	25
51765	4020601	3.50" X 12" PROBE ROD	11, 48
17066K	4030440	SP16 EXP. POINT W/ 1.75" OD, W/ O-RINGS (25/PKG)	37, 39
AT1200	4030007	1.25" DRIVE CAP, SHORT, W/ THREADS (G40 HAMMER)	3
AT1202	4020205	1.25" DRIVE CAP, SLOTTED, 5.50" LONG (GH40)	3
AT1203	4020231	1.25" PULL CAP, SLOTTED	3
AT1204	4030059	1.25" PULL CAP	3, 25
AT1212	4030279	1.25" X 12" PROBE ROD	3, 23, 27, 33, 48
AT1213	4030466	1.25" EXP. POINT HOLDER for 1.45" OD EXP. POINT	3
AT1214	4020208	1.25" EXP. POINT W/ O-RING (1.45" OD)	3
AT1214R	4030425	O-RING, 1.25" FOR 1.45" OD EXP. POINT (25/PKG)	3
AT1224	4030222	1.25" X 24" PROBE ROD	3, 33, 48
AT1236	4020229	1.25" X 36" PROBE ROD	3, 33, 48
AT1239	4020230	1.25" X 39"/1M PROBE ROD	3, 27, 29, 33, 48
AT1242	4020243	1.25" SOLID DRIVE POINT (2.50" OD)	3
AT1244	4020241	1.25" SOLID DRIVE POINT (1.75" OD)	3
AT1245	4020221	1.25" SOLID DRIVE POINT (1.45" OD)	3

# PART NUMBER REFERENCE GUIDE:

## Geoprobe® Part # to Hole Products Part #

GEOPROBE® PART #	HOLE PRODUCTS PART #	DESCRIPTION	PAGE #
AT1247	4020242	1.25" SOLID DRIVE POINT (2.00" OD)	3
AT1248	4030270	1.25" X 48" PROBE ROD	3, 23, 27, 29, 33, 48
AT1250R	4020217	O-RING, 1.25" PROBE ROD (25/PKG)	3, 39
AT1250R	4020217	O-RING, 1.25" PROBE ROD (25/PKG)	39
AT1252	4020244	1.25" SOLID DRIVE POINT (3.00" OD)	3
AT1260	4030267	1.25" X 60" PROBE ROD	3, 23, 27, 29, 33, 48
AT1266	4020209	1.25" DRIVE CAP, GAS SAMPLING	3
AT1266R	4020218	O-RING, 1.25" GAS SAMPLING CAP (25/PKG)	3
AT14	4020835	1.00" EXP. POINT (1.10" OD)	3, 5
AT14R	4030225	O-RING, 1.00" FOR 1.10" OD EXP. POINT (25/PKG)	3, 5
AT2015	4020034	2.25" EXP. POINT STANDARD (2.45" OD) W/ 1 O-RING	7
AT2015	4020034	2.25" EXP. DRIVE POINT (FOR .75" PREPACKS)	41
AT2015K	4200034	2.25" EXP. POINT W/ O-RING (32/PKG)	39
AT2100R	4020312	O-RING, 2.25" PROBE ROD (25/PKG)	7, 39
AT3215	4020038	3.25" EXP. POINT W/ O-RING - STEEL	9
AT3215	4020038	3.25" EXP. DRIVE POINT (FOR 1.00" OR 1.50" PREPACKS)	41
AT3215R	4020513	"O-RING, 3.25"" EXP. POINT (26/PKG)	9
AT6312R	4030435	O-RING, MC5 STOP PINS (25/PKG)	20
AT633	4030039	"TAP, 9/16"" REVERSE THREAD	20
AT67	4020169	36" EXTENSION ROD SS	49
AT671	4020167	48" EXTENSION ROD SS	50
AT6712	4030426	EXTENSION ROD CENTERING PLUG FOR STOP PIN	50
AT675	4020168	39"/1M EXTENSION ROD SS	50
AT68	4030476	EXTENSION ROD COUPLER	50
AT69	4020160	EXTENSION ROD HANDLE	50
AT695	4020170*	EXTENSION ROD QUICK LINK PIN	50
AT696	4020171*	EXTENSION ROD QUICK LINK BOX	50
AT7235	4020820	MC5 LINER SS 48"	20
AT726K	4020026	MC5 VINYL LINER CAPS (66/BOX)	19
AT737K	4020006	MC5 LINER CLEAR PVC 48" LIGHT DUTY (66/BOX)	19
AT8531K	4020016*	MC5 CORE CATCHER (28/BOX)	19
AT8532K	4020013	MC5 LINER SPACER RING (66/PKG)	19
AT8533K	4020013	MC5 LINER SPACER RING (500/PKG)	19
AT8534K	4020016*	MC5 CORE CATCHER (100/BOX)	19
AT921K	4020814	MC5 LINER CLEAR PVC 36" (66/BOX)	19
AT926K	4020001	MC5 LINER CLEAR PVC 24" (66/BOX)	19
AT927K	4020000	MC5 LINER CLEAR PVC 48" HEAVY DUTY (66/BOX)	19
AT928K	4020813	MC5 LINER CLEAR PVC 39"/1M (66/BOX)	19
BU1250	4030477	1.25"/1.50" NYLON BRUSH	3, 50
BU2125	4020302	2.25" NYLON BRUSH	7, 50
BU300	4030478	GROUNDWATER TOOL BRUSH	50
BU3250	4020516	3.25" NYLON BRUSH	9, 50
BU700	4020832	MC5 NYLON BRUSH	20, 50
DT3248K	4020109	DT325/DT35/DT37 LINER 48" W/O CORE CATCHER (42/BOX)	27, 29, 31
DT3260K	4020101	DT325/DT35/DT37 LINER 60" W/O CORE CATCHER (42/BOX)	27, 29, 31
DT4010	4020175	DT22 DRIVE BUMPER, RUBBER	25
DT4024K	4020127	DT22 LINER 24" W/O INTEGRAL CORE CATCHER (50/BOX)	25
DT4026K	4020150	DT22 VINYL LINER CAPS	25
DT4036K	4020129	DT22 LINER 36" W/O INTEGRAL CORE CATCHER (50/BOX)	25
DT4039K	4020125	DT22 LINER 39"/1M W/O INTEGRAL CORE CATCHER (50/BOX)	25
DT4045R	4020011	O-RING, EXP. CUTTING SHOE (50/PKG)	25
DT4048K	4020146	DT22 LINER 48" W/O INTEGRAL CORE CATCHER (50/BOX)	25
DT4051K	4020058	DT22 REBUILD KIT FOR LINER DRIVE HEAD	25
DT4052	4030038	DT22 DRIVE HEAD FOR LINERS W/ 1.25" MALE THREAD UP	25

GEOPROBE® PART #	HOLE PRODUCTS PART #	DESCRIPTION	PAGE #
DT4061K	4020008	DT22 LINER 60" W/O INTEGRAL CORE CATCHER (50/BOX)	25
DT4070R	4020009	O-RING, MC5 PISTON POINT	19
DT4070R	4020009	O-RING, DT22 DISCRETE POINT (25/PKG)	25
DT4070R	4020009	O-RING, SP16 STAINLESS STEEL SCREEN HEAD	37
DT4070R	4020009	O-RING, STAINLESS STEEL SCREEN	39
DT4124K	4020126	DT22 LINER 24" W/ INTEGRAL CORE CATCHER (50/BOX)	25
DT4136K	4020128	DT22 LINER 36" W/ INTEGRAL CORE CATCHER (50/BOX)	25
DT4139K	4020124	DT22 LINER 39"/1M W/ INTEGRAL CORE CATCHER (50/BOX)	25
DT4148K	4020147	DT22 LINER 48" W/ INTEGRAL CORE CATCHER (50/BOX)	25
DT4161K	4020007	DT22 LINER 60" W/ INTEGRAL CORE CATCHER (50/BOX)	25
GH1255	4020210	1.25" ROD GRIP HANDLE ASSEMBLY (GH40)	3
GH1555	4020425	1.50" ROD GRIP HANDLE ASSEMBLY (GH40)	5
GW1520	4020454	SP16 SCREEN, STAINLESS STEEL	37
GW1530	4020456	SP16 SCREEN, PVC REUSABLE	37
GW1535	4020460	"SP16 SCREEN PUSH ADAPTER	37
GW1540	4020458	"SP16 GROUT PLUG PUSH ADAPTER	37
GW1545	4020464	SP16 GROUT NOZZLE	37
GW1552K	4030082*	SP16/SP22 GROUT PLUG (25/PKG)	37, 39
GW1555	4020030	SP16 EXP. POINT W/ 1.625" OD W/ O-RING	37, 39
GW1555AL	4020466	SP16 EXP. POINT W/ O-RING, ALUMINIUM (25/PKG)	37, 39
GW1555K	4020030	SP16 EXP. POINT W/ O-RING (25/PKG)	37, 39
GW1555L	4020030	SP16 EXP. POINT W/ O-RING (120/PKG)	37, 39
GW1555R	4020110	O-RING, SP15/SP16 EXP. POINT (32/PKG)	37, 39
PR1214	4020219	1.25" EXP. POINT W/ O-RING (1.45" OD) SOIL GAS IMPLANT	3
PR1215	4020212	1.25" EXP. POINT HOLDER FOR 1.10" OD EXP. POINT	3
PR14	4030115	1.00" EXP. POINT W/ 1.10" OD FOR SOIL GAS IMPLANTS W/ O-RING	3, 5
WP1710	7850006	1.00" LOCKABLE EXPANSION PLUG	41
WP1715	7850004	1.50" LOCKABLE EXPANSION PLUG	41
WP1720	7850000	2.00" LOCKABLE EXPANSION PLUG	41
WP1775	7850007	.75" LOCKABLE EXPANSION PLUG	41

# PART NUMBER REFERENCE GUIDE:

## Geoprobe® Material # to Hole Products Part #

GEOPROBE® MAT #	HOLE PRODUCTS PART #	DESCRIPTION	PAGE #
101149	4020316	3.25" ROD GRIP SCREW	9
101149	4020316	3.50" ROD GRIP SCREW	11
101149	4020316	3.75" ROD GRIP SCREW	13
101149	4020316	4.50" ROD GRIP SCREW	15
101467	4020708	"O-RING, 4.50"" EXP. POINT	15
101901	4030402	O-RING, DT45 SOLID DRIVE POINT	33
102256	4030428	O-RING, SP16 FOR BOTTOM OF DRIVE HEAD	37
102981	4030044	O-RING, MC7 PISTON POINT	23
104378	5800005	2.00" X 60" PVC RISER	41
104397	5650080	2.00" PVC BOTTOM PLUG	41
104730	4030398	"O-RING, 4.50"" PROBE ROD (25/PKG)	15, 33
104852	5950005	2.00" X 60" PVC PIPE .010" SLOT	41
105017	4020452	O-RING, 2.25" GROUT INJECTION PULL CAP	3, 5, 7
105218	4030433	O-RING, 3.50" EXP. POINT (26/PKG)	11
200282	4020426	O-RING, 2.25" EXP. POINT (32/PKG)	7, 39, 41
200596	4020816	MC5 LINER CLEAR TEFLON 48"	20
200685	4020214	1.00"/1.25" ROD GRIP JAW (GH40)	3
201089	4020204	1.25" DRIVE CAP, THREADLESS (GH60)	3
201179	4020839	MC5 STOP PIN COUPLER	20
201183	4030274	MC5 PISTON ROD 48"	20
201185	4030250	3.25" X 60" PROBE ROD	9, 27, 48
201189	4020527	3.25" ROD GRIP BODY (GH60)	9
201273	4020520	3.25" SOLID DRIVE POINT (3.50" OD)	9
201275	4030049	3.25" DRIVE CAP, THREADLESS (GH60)	9, 27
201276	4030452	MC/MC5 QUICK LINK STOP PIN REMOVER	20, 50
201277	4020526	3.25" ROD GRIP HANDLE ASSEMBLY (GH60)	9
201280	4020470	3.25" ROD GRIP V-BLOCK RETAINING PIN	9
201280	4020470	3.50" ROD GRIP V-BLOCK RETAINING PIN	11
201282	4030055	3.25" EXP. POINT HOLDER 60" LONG	9
201325	4020514	O-RING, 3.25" PROBE ROD (25/PKG)	9
201325	4020514	O-RING, DT325/DT35 CUTTING SHOE	27, 29
201349	4020840	MC/MC5 STOP PIN FOR 1.25" & 2.25" DRIVE HEADS	20
201352	4020166	60" EXTENSION ROD SS	50
201385	4030338	DT325/DT35/DT37 DRIVE HEAD FOR SAMPLER SHEATH W/ 1.25" THREAD	27, 29, 31
201446	4020511	3.25" X 48" PROBE ROD	9, 27, 48
201447	4020504	3.25" EXP. POINT HOLDER 48" LONG	9
201448	4020500	3.25" DRIVE CAP, THREADLESS (GH40)	9
201470	4030281	MC5 PISTON ROD 60"	20
201682	4030235	1.50" X 60" PROBE ROD	5, 48
201813	5801015	SP22 X 60" PVC RISER (.750")	39
201813	5801015	.75" X 60" PVC RISER	41
201963	4030470	"3.25"" ROD GRIP JAW PAD (GH60)"	9
201963	4030470	3.50" ROD GRIP JAW PAD (GH60)	11
201963	4030470	3.75" ROD GRIP JAW PAD (GH60)	13
201963	4030470	4.50" ROD GRIP JAW PAD (GH60)	15
202008	4020525	3.25" ROD GRIP JAW (GH40)	9
202012	4020523	3.25" ROD GRIP HANDLE ASSEMBLY (GH40)	9
202026	4020140	3.25" EXP. POINT HOLDER SHORT (4.00" OD)	9
202059	5650006	.75" PVC BOTTOM PLUG	41
202115	4030041	1.50" DRIVE CAP, THREADLESS (GH60)	5
202121	4020423	1.50" SOLID DRIVE POINT THREADED (3.00" OD)	5
202135	5950000	1.00" X 60" PVC PIPE .010" SLOT	41
202136	5800000	1.00" X 60" PVC RISER	41
202137	5650005	1.00" PVC BOTTOM PLUG	41
202145	4030268	DT325 CENTERING DRIVE CAP	27
202221	4020121	DT22 BOLT FOR LINER DRIVE HEAD (20/PKG)	25
202234	4030050	3.25" PULL CAP	9, 27

GEOPROBE® MAT #	HOLE PRODUCTS PART #	DESCRIPTION	PAGE #
202248	4020414	1.50" X 48" PROBE ROD	5, 48
202313	4020508	3.25" X 12" PROBE ROD	9, 29, 48
202356	4020315	2.25" EXP. POINT IMPLANT ANCHOR (2.45" OD)	7
202363	4020510	3.25" X 39"/1M PROBE ROD	9, 27, 48
202364	4020501	3.25" EXP. POINT HOLDER 1M LONG	9
202366	4030356	"O-RING, FOR DT325/DT35 DISCRETE POINT (25/PKG)	27
202366	4030356	"O-RING, FOR DT325/DT35 DISCRETE POINT (25/PKG)	29
202491	4020330	2.25" CENTERING TOOL FOR EXTENSION RODS	7
202494	4020422	1.50" SOLID DRIVE POINT THREADED (2.50" OD)	5
202598	4030058	1.50" PULL CAP STANDARD NECK	5
202615	4020406	1.50" EXP. POINT HOLDER FOR 1.70" OD POINT	5
202630	4020415	1.50" PULL CAP W/ SLOT	5
202632	4030430	SP16 SAMPLER SHEATH	37
202633	4030432	SP16 DRIVE HEAD W/ 1.50" THREAD & .625" BORE	37
202637	4020421	1.50" SOLID DRIVE POINT THREADED (1.70" OD)	5
202660	4020216	1.25"/1.50" ROD GRIP JAW (GH60)	3, 5
202695	4030429	O-RING FOR 1.50" PROBE ROD (25/PKG)	5
202695	4030434	O-RING, SP16 PROBE ROD FOR TOP OF DRIVE HEAD	37
202714	4030232	1.50" X 12" PROBE ROD	5, 48
202715	4020412	1.50" X 24" PROBE ROD	5, 48
202723	4030105	MC/MC5 STOP PIN FOR 1.50" DRIVE HEAD	20
202724	4020220	1.25"/1.50" ROD GRIP HANDLE ASSEMBLY (GH60)	3, 5
202730	4030069	1.50" ROD GRIP JAW (GH40)	5
202736	4020403	1.50" DRIVE CAP, W/ THREADS (GH40)	5
202743	4020402	1.50" DRIVE CAP, SLOTTED, w/ THREADS (GH40)	5
202789	4020200	ADAPTER, 1.25" BOX TO 1.50" PIN	3, 5, 50
202790	4020201	ADAPTER, 1.50" BOX TO 1.25" PIN	3, 5, 50
202821	4030442	SP16 SCREEN, PVC DISPOSABLE	37
202873	4020821	MC5 LINER SS 60"	20
202929	4020232	1.25" GROUT INJECTION PULL CAP	3
202930	4020416	1.50" GROUT INJECTION PULL CAP	5
202948	4020308	"3.25""/3.50"" ROD GRIP HAMMER V-BLOCK (GH60)	9, 11
203036	4020833	1.25" PULL CAP W/ 1/2" NPT FEMALE THREAD	3
203079	4020033	1.50" X 60" X .010" SLOT PREPACKED SCREEN (2.50" OD) 8TPI	41
203080	5951001	1.50" X 60" PVC PIPE .010" SLOT	41
203081	5801002	1.50" X 60" PVC RISER	41
203082	5650009	1.50" PVC BOTTOM PLUG	41
203095	4020021	.75" X 60" X .010" SLOT PREPACKED SCREEN (1.40" OD) - 8TPI	41
203096	4020022	1.00" X 60" X .010" SLOT PREPACKED SCREEN (2.50" OD) - 8TPI	41
203101	4030437	.75" X 60" SCH 40 PVC PIPE .010" SLOT	39, 41
203193	4020411	1.50" X 39"/1M PROBE ROD	5, 48
203208	4030455	O-RING, 1.25 & 1.50 GROUT INJECTION PULL CAP	5, 7
203262	4030444	SP16 DRIVE HEAD W/ 1.50" THREAD & .500" BORE	37
203284	4030252	3.25" X 24" PROBE ROD	9, 48
203530	4020314	2.25" EXP. POINT EXT. SHANK (2.45" OD) W/ 3 O-RINGS	7
203559	4020831	MC5 PLUNGER FOR HYDRAULIC LINER	20
203799	4020522	3.25" SPT CUTTING SHOE W/ 2.38" ID X 3.750" OD FOR SPLIT SPOON	9
203844	4020521	3.25" SPT SOLID DRIVE POINT W/ 1.50" MALE THREAD FOR SPLIT SPOON	9
203895	4020407	1.50" EXP. POINT HOLDER FOR 1.10" OD POINT	5
203909	4020420	1.50" SOLID DRIVE POINT THREADED (1.50" OD)	5
203988	4030224	1.25" X 48" LIGHTWEIGHT PROBE ROD	3, 19, 25, 27, 29, 39, 49
204217	4030060	MC5 CUTTING SHOE 1.50" ID W/ STANDARD SHANK (2.30" OD)	19
204218	4030035	MC5 SAMPLER TUBE 48"	19
204236	4030043	DT22 DRIVE CAP 1.25" THREADLESS	25

# PART NUMBER REFERENCE GUIDE:

## Geoprobe® Material # to Hole Products Part #

GEOPROBE® MAT #	HOLE PRODUCTS PART #	DESCRIPTION	PAGE #
204237	4030278	DT22 DISCRETE POINT FOR USE W/ 1.25" INNER RODS	25
204257	4030042	MC5 DRIVE HEAD X 1.50" FOR STOP PIN	19
204259	4030030	MC5 SAMPLER TUBE 60"	19
204305	4020203	1.25"/1.50" ROD GRIP BODY (GH60)	3, 5
204389	4030088	MC5 DRIVE CAP FOR CENTER RODS	19, 23
204390	4020800	MC5 CENTER ROD PLUG 1.25" MALE THREAD	19
204400	4020202	1.25"/1.50" ROD GRIP BODY (GH40)	3, 5
204401	4020336	2.25" ROD GRIP BODY (GH40)	7
204402	4020524	3.25" ROD GRIP BODY (GH40)	9
204403	4020333	2.25" ROD GRIP BODY (GH60)	7
204500	4030070	MC5 CUTTING SHOE 1.50" ID W/ EXT. SHANK (2.375" OD)	19
204550	4020829	MC5 SAMPLER TUBE 36"	19
204551	4020830	MC5 SAMPLER TUBE 39"/1M	19
204764	4020319	2.25" SOLID DRIVE POINT (2.50" OD)	7
204766	4030244	2.25" x 48" PROBE ROD	7, 13, 25, 33, 39, 48
204767	4030245	2.25" x 60" PROBE ROD	7, 13, 25, 33, 39, 48
204774	4030072	DT22 SHOE STANDARD SIZE 2.375" OD X 1.125" ID	25
204777	4020323	2.25" x 12" PROBE ROD	7, 13, 25, 33, 39, 48
204778	4020325	2.25" x 39"/1M PROBE ROD	7, 13, 25, 33, 39, 48
204779	4020139	2.25" EXP. POINT HOLDER SHORT (2.50" OD)	7
204781	4020309	2.25" EXP. POINT HOLDER 48" LONG ( 2.25" OD)	7
204782	4020310	2.25" EXP. POINT HOLDER 60" LONG 2.25" OD)	7
204783	4020320	2.25" SOLID DRIVE POINT (3.00" OD)	7
204784	4020321	2.25" SOLID DRIVE POINT (3.50" OD)	7
204785	4020300	ADAPTER, 2.25" BOX TO 1.50" PIN	7, 50
204786	4020301	ROD TO CAP ADAPTER, 2.25" PIN TO HSA	7, 50
204787	4020304	2.25" DRIVE CAP, W/ THREADS (GH40)	7, 25
204797	4020700	4.50" X 48" PROBE ROD	15, 33, 48
204985	4030062	MC5 CUTTING SHOE 1.25" ID W/ EXT. SHANK (2.375" OD)	19
205021	4030040	MC5 DRIVE HEAD X 1.25" FOR STOP PIN	19
205080	4020703	4.50" DRIVE CAP, BOX DOWN, THREADLESS (GH60/80)	15, 33
205098	4030342	DT325/DT35/DT37 LINER RETAINER W/ GROOVE	27, 29, 31
205099	4030362	DT325/DT35/DT37 SAMPLER SHEATH 60"	27, 29, 31
205100	4030322	DT325 CUTTING SHOE 1.75" ID X 3.450" OD	27
205110	4030364	DT325/DT35/DT37 SAMPLER SHEATH 72"	27, 29, 31
205113	4030080	MC5 POINT CLOSED PISTON UNDER SIZED 1.35" OD W/ O-RINGS	19
205120	4020815	4.50" SOLID POINT, THREADED (5.00" OD)	15
205182	4020103	ADJUSTABLE CENTER ROD CLAMP FOR 1.25" RODS	25
205232	4030277	1.25" X 60" LIGHTWEIGHT PROBE ROD	3
205232	4030277	1.25" X 60" LIGHTWEIGHT PROBE ROD	19, 25, 27, 29, 39, 49
205264	4030360	DT325/DT35/DT37 SAMPLER SHEATH 48"	27, 29, 31
205265	4030358	DT325/DT35/DT37 SAMPLER SHEATH 39"/1M	27, 29, 31
205279	4030336	DT325/DT35 DISCRETE POINT 1.75" OD W/ 1.25" PIN UP	27, 29
205299	4030344	DT325/DT35 RETAINER WRENCH	27, 29, 31
205371	4030280	MC5 DRIVE HEAD X 1.50" W/ 1/4" BORE NO STOP PIN	19
205372	4020806	MC5 DRIVE HEAD X 1.25" W/ 1/8" BORE NO STOP PIN	19
205387	4030079	MC5 POINT CLOSED PISTON STANDARD SIZE 1.50" OD W/ O-RING	19
205424	4030320	DT325 HOLDER FOR EXP. CUTTING SHOE	27
205426	4030366	DT325/DT35/DT37 EXP. CUTTING SHOE (1.75" ID)	27, 29, 31
205449	4030077	DT325 CUTTING SHOE 1.85" ID	27
205450	4030271	DT325/DT35 DISCRETE POINT 1.85" OD W/ 1.25" PIN UP	27, 29
205475	4020812	MC5 DRIVE HEAD X 2.25" W/ 1.375" BORE	19
205476	4030045	MC5 DRIVE HEAD X 2.25" FOR STOP PIN	19
205481	4020311	2.25" EXP. POINT HOLDER SHORT( 2.25" OD)	7

GEOPROBE® MAT #	HOLE PRODUCTS PART #	DESCRIPTION	PAGE #
205555	4020704	4.50" X 60" PROBE ROD	15, 33, 48
205565	4020334	2.25" ROD GRIP JAW (GH60)	7
205636	5700038	2.00" WELL DEVELOPMENT TOOL "ENV. SERIES"	41
205663	4030368	DT325/DT35/DT37 LINER SPACER CONNECTOR	27, 29, 31
205664	4020332	2.25" ROD GRIP HANDLE ASSEMBLY (GH60)	7
205676	4020337	2.25" ROD GRIP JAW (GH40)	7
205678	4020335	2.25" ROD GRIP HANDLE ASSEMBLY (GH40)	7
205690	4020705	4.50" LIFTING SWIVEL PULL CAP, BOX DOWN	15
205697	4020828	MC5 ADAPTER FOR HYDRAULIC EXTRUDER	20
205705	4020060	MC5 CUTTING SHOE 1.35" ID W/ STANDARD EXT. SHANK (2.375" OD)	19
205731	4020837	MC5 CUTTING SHOE (2.25" OD) EXT SHANK	20
205734	4030370	4.50" CASING SHOE (3.55" ID, 5.00" OD)	15
205760	4030410	DT45 SAMPLE TUBE 48"	33
205761	4030412	DT45 SAMPLE TUBE 60"	33
205762	4030414	DT45 SAMPLE TUBE 72"	33
205770	4030384	DT45 DRIVE HEAD FOR 1.25" CENTER RODS	33
205773	4020909	MC7 CUTTING SHOE WRENCH / DT45 RETAINER WRENCH	23, 33, 50
205797	4030392	DT45 LINER SPACER CONNECTOR	33
205800	4030416	DT45 CUTTING SHOE	33
206187	4020303	2.25" DRIVE CAP, THREADLESS (GH40)	7, 19, 25, 39
206239	4020234	1.25" LEAF PULLER ASSEMBLY	3
206249	4030046	2.25" DRIVE CAP, THREADLESS, LONG (GH60)	7, 19, 25, 39
206336	4020506	4.50" ROD GRIP HAMMER V-BLOCK (GH60)	15
206412	4020706	4.50" X 24" PROBE ROD	15, 33, 48
206433	4020707	4.50" ROD GRIP HANDLE ASSEMBLY (GH60)	15
206460	4030068	MC5 CUTTING SHOE 1.35" ID W/ EXT. SHANK (2.30" OD)	19
206515	4020701	4.50" ROD GRIP BODY (GH60)	15
206525	4020226	1.25" X 39"/1M LIGHTWEIGHT PROBE ROD	3, 19, 25, 27, 29, 39, 49
206527	4030386	DT45 DRIVE HEAD FOR 2.25" CENTER RODS	33
206531	4030406	DT45 LINER RETAINER	33
206538	4030420	DT45 CENTERING DRIVE CAP 2.25" ROD	33
206560	4030071	MC5 CUTTING SHOE W/ MC5 THREAD, STANDARD SHANK (2.25" OD)	19
206588	4030242	2.25" x 24" PROBE ROD	7, 25, 33, 39, 48
206592	4020838	4.50" SOLID DRIVE / DISCRETE POINT	15
206593	4020836	O-RING, 4.50" SOLID DRIVE / DISCRETE POINT (10/PKG)	15
206601	4030380	DT45 DRIVE CAP BUFFERING 1.25" RODS	33
206602	4030382	DT45 DRIVE CAP BUFFERING 2.25" ROD	33
206638	4030388	DT45 EXP. CUTTING SHOE HOLDER 4.50" OD (3.75 ID)	33
206643	4020329	2.25" LEAF PULLER ASSEMBLY	7
206644	4020029	2.00" X 60" X .010" SLOT PREPACKED SCREEN (3.40" OD) - 2TPI	41
206706	4020324	2.25" x 36" PROBE ROD	7, 25, 33, 39, 48
206823	4020326	2.25" PULL CAP HD	7, 25
206861	4020488	"2.25" EXP. POINT HOLDER	39
206876	4020327	2.25" LIFTING SWIVEL PULL CAP, BOX DOWN	7
206890	4020702	4.50" X 39"/1M PROBE ROD	15, 33, 48
206898	4030408	DT45 SAMPLE TUBE 39"/1M	33
206901	4030404	DT45 SOLID DRIVE / DISCRETE POINT (2.25" BOX UP)	33
207000	4020906*	MC7/DT45 CORE CATCHER	23, 33
207012	5700160	1.50" WELL DEVELOPMENT TOOL"ENV. SERIES"	41
207105	4030418	DT45 EXP. CUTTING SHOE	33
207243	4030315	4.50" CASING SHOE (3.55" ID, 6.00" OD)	15
207255	4030061	4.50" FLANGE PULL ROD	15
207256	4030025	2.25" FLANGE PULL ROD	7
207261	4020413	1.50" X 36" PROBE ROD	5, 48
207272	4020517	3.25" LIFTING SWIVEL PULL CAP, BOX DOWN	9

# PART NUMBER REFERENCE GUIDE:

## Geoprobe® Material # to Hole Products Part #

GEOPROBE® MAT #	HOLE PRODUCTS PART #	DESCRIPTION	PAGE #
207276	5700037	1.00" WELL DEVELOPMENT TOOL "ENV. SERIES"	41
207277	4030431	3.25" FLANGE PULL ROD	9
207282	4020206	1.25" DRIVE CAP, LONG, THREADLESS (GH40)	3
207352	4020328	2.25" LIFTING SWIVEL PULL CAP, PIN DOWN	7
207439	4020113	MC7/DT45 VINYL LINER CAPS	23, 33
207515	4030369	4.50" SOLID POINT, THREADED (6.00" OD)	15
207649	4020710	4.50" EXP. POINT HOLDER SHORT (4.50" OD)	15
207679	4030057	3.50" DRIVE CAP, THREADLESS (GH60/80)	11, 29
207680	4030305	3.50" SOLID DRIVE POINT	11
207726	4030332	DT35 HOLDER FOR EXP. CUTTING SHOES	29
207735	4020045	4.50" EXP. POINT W/ O-RING (5.00" OD)	15
207735	4020045	4.50" EXP. DRIVE POINT (FOR 2.00" PREPACKS)	41
207845	4030421	2.25" GROUT INJECTION PULL CAP	7
207873	4030067	4.50" HD PULL CAP	15
208053	4030318	DT325 BUFFERING DRIVE CAP	27
208066	4030076	DT35 CUTTING SHOE STANDARD 1.85" ID X 3.75" OD	29
208069	4020240	3.50" EXP. POINT HOLDER 60" LONG	11
208094	4020474	SET SCREW SERVICE KIT FOR SP22	39
208095	4020490	O-RING, SERVICE KIT FOR SP22	39
208102	4020484	SP22 SCREEN HEAD ADAPTER (PVC) FOR PVC SCREENS	39
208113	4020468	SP22 CHECK VALVE TUBING, STAINLESS	39
208114	4030310	SP22 X 48" STAINLESS STEEL SCREEN	39
208115	4030272	3.50" LIFTING SWIVEL PULL CAP, BOX DOWN	11
208219	4030266	3.50" X 24" PROBE ROD	11, 29, 48
208220	4030009	3.50" FLANGE PULL ROD	11
208238	4020472	SP22 X 12" STAINLESS STEEL SCREEN	39
208259	4030330	DT35/DT37 CENTERING DRIVE CAP	29, 31
208316	4020482	SP22 SCREEN HEAD ADAPTER (SS) FOR PVC SCREENS	39
208318	4020476	SP22 X 48" PVC SCREEN (2/BOX)	39
208319	4020478	SP22 X 12" PVC SCREEN (2/BOX)	39
208446	4030264	3.50" X 48" PROBE ROD	11, 29, 48
208447	4030075	3.50" EXP. POINT HOLDER 48" LONG	11
208449	4030084	3.50" EXP. POINT HOLDER 1M LONG	11
208460	4030605	3.50" DRIVE CAP, THREADLESS (GH40)	11
208461	4020803	3.50" ROD GRIP HANDLE ASSEMBLY (GH40)	11
208472	4030269	DT325/DT35/DT37 LINER RETAINER, HEAVY DUTY	27, 29, 31
208502	4030334	DT35 CUTTING SHOE 1.85" ID X 3.50" OD	29
208504	4020600	3.50" EXP. POINT W/ O-RING	11, 41
208510	4020136	4.50" EXP. POINT W/ O-RING (4.50" OD)	15
208532	4020709	4.50" X 12" PROBE ROD	15, 33, 48
208806	4020417	1.50" LEAF PULLER ASSEMBLY	5
209428	4030350	DT22 THREAD CUTTING DRIVE HEAD (FISHING TOOL)	25
209748	4030345	1.50" LIFTING SWIVEL PULL CAP	5
209949	4020227	1.25" X 36" LIGHTWEIGHT PROBE ROD	3, 19, 25, 39, 49
209991	4030095	DT22/SP22 EXP. POINT HOLDER FOR 1.625" OD EXP. POINTS	25, 39
210051	4030326	DT35/DT37 BUFFERING DRIVE CAP	29, 31
210052	4030328	DT35/DT37 BUFFERING DRIVE CAP, HEAVY DUTY	29, 31
210092	4030427	1.25" LIFTING SWIVEL PULL CAP	3
210532	4020804	3.50" ROD GRIP HANDLE ASSEMBLY (GH60)	11
210533	4020810	3.50" ROD GRIP BODY (GH60)	11
210856	4020905	MC7 CORE CATCHER SPACER RING	23
211776	4030446	SP16 DRIVE HEAD W/ 1.25" THREAD & .625" BORE	37
211777	4030448	SP16 DRIVE HEAD W/ 1.25" THREAD & .500" BORE	37
211798	4030026	2.25" DRIVE CAP, SLOTTED, THREADLESS (GH60)	7
211838	4020903	MC7 SAMPLE SHEATH 60"	23
211889	4020900	MC7 DRIVE HEAD W/ 2.25" PIN	23
212038	4020605	4.50" DRIVE CAP, PIN DOWN, THREADLESS (GH60/80)	15

GEOPROBE® MAT #	HOLE PRODUCTS PART #	DESCRIPTION	PAGE #
212290	4030056	3.50" HD/DT35 PULL CAP	11, 29
212548	4020802	DRIVE CUSHION ASSEMBLY	25
212678	4030093	DT22 HOLDER FOR EXP. SHOES	25
213362	4020601	3.50" X 12" PROBE ROD	11, 48
213617	4030440	SP16 EXP. POINT W/ 1.75" OD W/ O-RING	37, 39
213617	4030440	SP16 EXP. POINT W/ 1.75" OD, W/ O-RINGS (25/PKG)	37, 39
213748	4030007	1.25" DRIVE CAP, SHORT, W/ THREADS (G40 HAMMER)	3
213749	4020205	1.25" DRIVE CAP, SLOTTED, 5.50" LONG (GH40)	3
213750	4020231	1.25" PULL CAP, SLOTTED	3
213751	4030059	1.25" PULL CAP	3, 25
213753	4030279	1.25" X 12" PROBE ROD	3, 23, 27, 33, 48
213754	4030466	1.25" EXP. POINT HOLDER FOR 1.45" OD EXP. POINT	3
213758	4030222	1.25" X 24" PROBE ROD	3, 33, 48
213762	4020229	1.25" X 36" PROBE ROD	3, 33, 48
213763	4020230	1.25" X 39"/1M PROBE ROD	3, 27, 29, 33, 48
213765	4020243	1.25" SOLID DRIVE POINT (2.50" OD)	3
213766	4020241	1.25" SOLID DRIVE POINT (1.75" OD)	3
213767	4020221	1.25" SOLID DRIVE POINT (1.45" OD)	3
213768	4020242	1.25" SOLID DRIVE POINT (2.00" OD)	3
213769	4030270	1.25" X 48" PROBE ROD	3, 23, 27, 29, 33, 48
213771	4020217	O-RING, 1.25" PROBE ROD (25/PKG)	3, 39
213772	4020244	1.25" SOLID DRIVE POINT (3.00" OD)	3
213773	4030267	1.25" X 60" PROBE ROD	3, 23, 27, 29, 33, 48
213775	4020209	1.25" DRIVE CAP, GAS SAMPLING	3
213776	4020218	O-RING, 1.25" GAS SAMPLING CAP (25/PKG)	3
213778	4020835	1.00" EXP. POINT (1.10" OD)	3, 5
213782	4030225	O-RING, 1.00" FOR 1.10" OD EXP. POINT (25/PKG)	3, 5
213788	4020034	2.25" EXP. POINT STANDARD (2.45" OD) W/ 1 O-RING	7
213788	4020034	2.25" EXP. DRIVE POINT (FOR .75" PREPACKS)	41
213788	4020034	2.25" EXP. POINT W/ O-RING (32/PKG)	39
213790	4020312	O-RING, 2.25" PROBE ROD (25/PKG)	7, 39
213798	4020038	3.25" EXP. POINT W/ O-RING - STEEL	9
213798	4020038	3.25" EXP. DRIVE POINT (FOR 1.00" OR 1.50" PREPACKS)	41
213800	4020513	"O-RING, 3.25" EXP. POINT (26/PKG)	9
213812	4030435	O-RING, MC5 STOP PINS (25/PKG)	20
213832	4020169	36" EXTENSION ROD SS	49
213833	4020167	48" EXTENSION ROD SS	50
213834	4030426	EXTENSION ROD CENTERING PLUG FOR STOP PIN	50
213835	4020168	39"/1M EXTENSION ROD SS	50
213836	4030476	EXTENSION ROD COUPLER	50
213837	4020160	EXTENSION ROD HANDLE	50
213838	4020170*	EXTENSION ROD QUICK LINK PIN	50
213839	4020171*	EXTENSION ROD QUICK LINK BOX	50
213840	4020820	MC5 LINER SS 48"	20
213843	4020026	MC5 VINYL LINER CAPS (66/BOX)	19
213856	4020016*	MC5 CORE CATCHER (28/BOX)	19
213857	4020013	MC5 LINER SPACER RING (66/PKG)	19
213872	4020814	MC5 LINER CLEAR PVC 36" (66/BOX)	19
213873	4020001	MC5 LINER CLEAR PVC 24" (66/BOX)	19
213874	4020813	MC5 LINER CLEAR PVC 39"/1M (66/BOX)	19
213909	4020150	DT22 VINYL LINER CAPS	25
213910	4020129	DT22 LINER 36" W/O INTEGRAL CORE CATCHER (50/BOX)	25
213911	4020125	DT22 LINER 39"/1M W/O INTEGRAL CORE CATCHER (50/BOX)	25
213913	4020011	O-RING, EXP. CUTTING SHOE (50/PKG)	25
213914	4020146	DT22 LINER 48" W/O INTEGRAL CORE CATCHER (50/BOX)	25
213915	4020058	DT22 REBUILD KIT FOR LINER DRIVE HEAD	25

# PART NUMBER REFERENCE GUIDE:

## Geoprobe® Material # to Hole Products Part #

GEOPROBE® MAT #	HOLE PRODUCTS PART #	DESCRIPTION	PAGE #
213916	4030038	DT22 DRIVE HEAD FOR LINERS W/ 1.25" MALE THREAD UP	25
213917	4020008	DT22 LINER 60" W/O INTEGRAL CORE CATCHER (50/BOX)	25
213918	4020009	O-RING, MC5 PISTON POINT	19
213918	4020009	O-RING, DT22 DISCRETE POINT (25/PKG)	25
213918	4020009	O-RING, SP16 STAINLESS STEEL SCREEN HEAD	37
213918	4020009	O-RING, STAINLESS STEEL SCREEN	39
213919	4020128	DT22 LINER 36" W/ INTEGRAL CORE CATCHER (50/BOX)	25
213920	4020124	DT22 LINER 39"/1M W/ INTEGRAL CORE CATCHER (50/BOX)	25
213922	4020147	DT22 LINER 48" W/ INTEGRAL CORE CATCHER (50/BOX)	25
213924	4020007	DT22 LINER 60" W/ INTEGRAL CORE CATCHER (50/BOX)	25
213950	4020210	1.25" ROD GRIP HANDLE ASSEMBLY (GH40)	3
213951	4020425	1.50" ROD GRIP HANDLE ASSEMBLY (GH40)	5
214027	4020454	SP16 SCREEN, STAINLESS STEEL	37
214028	4020456	SP16 SCREEN, PVC REUSABLE	37
214029	4020460	*SP16 SCREEN PUSH ADAPTER	37
214030	4020458	*SP16 GROUT PLUG PUSH ADAPTER	37
214031	4020464	SP16 GROUT NOZZLE	37
214036	4020030	SP16 EXP. POINT W/ O-RING (25/PKG)	37, 39
214036	4020030	SP16 EXP. POINT W/ O-RING (120/PKG)	37, 39
214037	4020110	O-RING, SP15/SP16 EXP. POINT (32/PKG)	37, 39
214201	4020219	1.25" EXP. POINT W/ O-RING (1.45" OD) SOIL GAS IMPLANT	3
214202	4020212	1.25" EXP. POINT HOLDER FOR 1.10" OD EXP. POINT	3
214205	4030115	1.00" EXP. POINT W/ 1.10" OD FOR SOIL GAS IMPLANTS W/ O-RING	3, 5
214781	4020603	3.50" X 39"/1M PROBE ROD	11, 29, 48
215278	4020307	DT22 EXP. CUTTING SHOE (2.375" OD) W/ O-RINGS	25
215664	4030265	3.50" X 60" PROBE ROD	11, 29, 48
215665	4020841	MC5 SAMPLER TUBE 24"	19
216119	4020901	MC7 CENTER ROD SPACER	23
216121	4020908	MC7 SHOE CUTTING	23
216256	4030480	3.75" SPT CENTERING DRIVE CAP, 2.25"	13
216883	4020904	MC7 SAMPLE SHEATH 48"	23
216885	4020902	MC7 SAMPLE SHEATH 72"	23
218055	4020907	MC7 PISTON POINT W/ O-RING	23
219147	4020004	MC5 LINER CLEAR TEFLON 60"	20
219275	4030462	3.75" X 60" PROBE ROD	13
219275	4030462	3.75" X 60" PROBE ROD	31
219275	4030462	3.75" X 60" PROBE ROD	48
219276	4030453	3.75" DRIVE CAP, THREADLESS (GH60/80)	13
219276	4030453	3.75" DRIVE CAP, THREADLESS (GH60/80)	31
219277	4030463	3.75" SOLID DRIVE POINT	13
219278	4030456	3.75" X 24" PROBE ROD	13
219278	4030456	3.75" X 24" PROBE ROD	31
219278	4030456	3.75" X 24" PROBE ROD	48
219559	4030451	3.75" EXP. POINT HOLDER SHORT(3.75 OD)	13
219582	4030483	DT37 CUTTING SHOE	31
219601	4030464	3.75" EXP. POINT W/ O-RING 4.00" OD	13
219601	4020097	3.75" EXP. DRIVE POINT	41
219620	4030484	DT37 HOLDER FOR EXP. CUTTING SHOES	31
219951	4030482	3.75" SPT CUTTING SHOE W/ 2.85" BORE FOR 3.75" RODS	13
220370	4030469	3.75" LIFTING SWIVEL PULL CAP, BOX DOWN	13
220390	4030474	3.75" ROD WIPER	13
220390	4030474	3.75" PROBE ROD WIPER	50
220395	4030457	3.75" X 12" PROBE ROD	13
220395	4030457	3.75" X 12" PROBE ROD	31
220395	4030457	3.75" X 12" PROBE ROD	48
220413	4030472	3.75" ROD GRIP HANDLE ASSEMBLY (GH60)	13
220535	4030467	3.75" PULL CAP	13

GEOPROBE® MAT #	HOLE PRODUCTS PART #	DESCRIPTION	PAGE #
220535	4030467	DT37 3.5 PULL CAP	31
220539	4030458	3.75" X 48" PROBE ROD	13
220539	4030458	3.75" X 48" PROBE ROD	31
220539	4030458	3.75" X 48" PROBE ROD	48
220635	4030481	3.75" SPT DRIVE POINT FOR 3.75" RODS (2.25" PIN UP X 2.80" OD)	13
220730	4030471	3.75" FLANGE PULL ROD	13
600131	4020005	MC5 LINER CLEAR PVC 60" (66/BOX)	19
600207	4020519	*O-RING, 3.25" EXP. POINT (EACH)	9
600218	4020480	SP22 X 15" PVC SCREEN (2/BOX)	39
600232	4020112	DT325/DT35/DT37 VINYL LINER CAPS	27, 29, 31
600341	4020211	1.25"/1.50" ROD WIPER	3, 5, 50
600412	4020331	2.25" ROD WIPER	7, 50
600418	4020518	3.25" ROD WIPER	9, 50
600418	4020518	3.50" ROD WIPER	11, 50
600422	4020100	DT325/DT35/DT37 LINER 60" W/ CORE CATCHER (42/BOX)	27, 29, 31
600423	4020108	DT325/DT35/DT37 LINER 48" W/ CORE CATCHER (42/BOX)	27, 29, 31
600424	4030348	DT325/DT35/DT37 LINER 39"/1M W/ CORE CATCHER (42/BOX)	27, 29, 31
600428	4030352	O-RING, DT325, DT35, DT37 LINER RETAINER (25/PKG)	27, 29, 31
600443	4030346	DT325/DT35/DT37 LINER SPACER 11.50" REFILL	27, 29, 31
600448	4030475	4.50" PROBE ROD WIPER	50
600448	4030475	4.50" ROD WIPER	15
600484	4030396	DT45 LINER SPACER 12"	33
600528	4030400	O-RING, DT45 EXP. CUTTING SHOE	33
600595	4020462*	SP22 PVC BOTTOM SCREEN PLUG	39
600719	4020105	DT45 LINER CLEAR PVC 60" (18/BOX)	23, 33
600720	4030390	DT45 LINER CLEAR PVC 72" (18/BOX)	23, 33
600721	4020107	DT45 LINER CLEAR PVC 48" (18/BOX)	23, 33
600977	4030039	*TAP, 9/16" REVERSE THREAD	20
600984	4020006	MC5 LINER CLEAR PVC 48" LIGHT DUTY (66/BOX)	19
600988	4020013	MC5 LINER SPACER RING (500/PKG)	19
600989	4020016*	MC5 CORE CATCHER (100/BOX)	19
600993	4020000	MC5 LINER CLEAR PVC 48" HEAVY DUTY (66/BOX)	19
600996	4030477	1.25"/1.50" NYLON BRUSH	3, 50
600998	4020302	2.25" NYLON BRUSH	7, 50
600999	4030478	GROUNDWATER TOOL BRUSH	50
601000	4020516	3.25" NYLON BRUSH	9, 50
601003	4020832	MC5 NYLON BRUSH	20, 50
601004	4020109	DT325/DT35/DT37 LINER 48" W/O CORE CATCHER (42/BOX)	27, 29, 31
601005	4020101	DT325/DT35/DT37 LINER 60" W/O CORE CATCHER (42/BOX)	27, 29, 31
601006	4020175	DT22 DRIVE BUMPER, RUBBER	25
601033	4030082*	SP16/SP22 GROUT PLUG (25/PKG)	37, 39
601071	7850006	1.00" LOCKABLE EXPANSION PLUG	41
601072	7850004	1.50" LOCKABLE EXPANSION PLUG	41
601073	7850000	2.00" LOCKABLE EXPANSION PLUG	41
601078	7850007	.75" LOCKABLE EXPANSION PLUG	41
N/A	4020822	MC5 LINER SS LONG SECTION	20
N/A	4020823	MC5 LINER SS SHORT SECTION	20
N/A	4020826	MC5 PISTON ROD 36"	20
N/A	4020825	MC5 PISTON ROD 24"	20
N/A	4020824	MC5 PISTON ROD 39"/1M	20
N/A	4020012	O-RING, SCREEN HEAD ADAPTER	39
N/A	4020401	1.50" DRIVE CAP, SLOTTED, THREADLESS(GH40)	5
N/A	4020208	1.25" EXP. POINT W/ O-RING (1.45" OD)	3
N/A	4030425	O-RING, 1.25" FOR 1.45" OD EXP. POINT (25/PKG)	3
N/A	4020127	DT22 LINER 24" W/O INTEGRAL CORE CATCHER (50/BOX)	25
N/A	4020126	DT22 LINER 24" W/ INTEGRAL CORE CATCHER (50/BOX)	25
N/A	4020030	SP16 EXP. POINT W/ 1.625" OD W/ O-RING	37, 39
N/A	4020466	SP16 EXP. POINT W/ O-RING, ALUMINIUM (25/PKG)	37, 39

## OUR PRODUCTS



Auger Tools



Direct Push Tools



Drill Rods & Subs



DTH Hammers  
& Bits

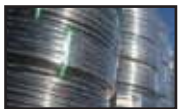

Geothermal  
Products



Grouting Equipment  
& Accessories



Hole Sampling & Monitoring



Low Carbon Steel Casing  
& Accessories



Pipe Handling & Hoisting



PVC Well Screen, Casing  
& Accessories



Safety Equipment



Sonic Drilling Tools



Water Swivels & Spares



Diamond Core Tools



Drill Bits



Drilling Fluid Additives & Grouts



Fishing Tools



Ground Cover Protection



HDD Tools



Hoses & Fittings



Overburden Drilling Systems



Pumps & Spares



Reverse Circulation Drilling Tools



Sand, Cement & Asphalt



Stainless Steel Well Screen,  
Casing & Accessories



Well Completion & Protection



**hole**  
**PRODUCTS**  
*Drill with us.*

## OUR COMPANY

Hole Products is a leading global provider of high performance drilling supplies, tools and equipment to the direct push, environmental, geotechnical, geothermal, HDD, mineral exploration, rotary and sonic drilling industries.

We combine hundreds of years of drilling supply and service experience, a vast inventory, multiple stocking locations, and worldwide shipping capabilities. Our drilling tools are preceded by extensive R&D, field tested, and backed by our unmatched commitment to service and support.

In addition, our diverse team offers industry leading inventory management, sourcing, logistics, troubleshooting, and product innovation solutions.

Call now, to discover the Hole Products advantage!



WWW.**hole** **PRODUCTS**.com